



# Hilti HIT-RE 100



qr.hilti.com/  
manual/?id=2127554

English  
Deutsch  
Français  
Italiano  
Español  
Português  
Nederlands  
Ελληνικά  
Türkçe  
中文  
繁體中文  
한국어  
عربي  
پاسا ملايو  
Tiếng Việt  
ไทย

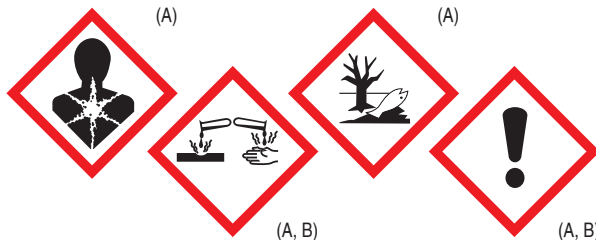

## DANGER

















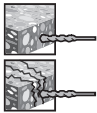

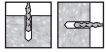



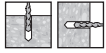
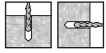



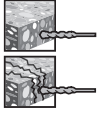

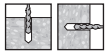

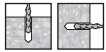

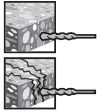

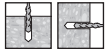





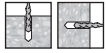

**Contains:** 2,2'-[[1-methylethylidene]bis(4,1-phenyleneoxymethylene)]bisoxirane (A); Formaldehyde, oligomeric reaction products with 1-chloro-2,3-epoxypropane and phenol (A); Trimethylolpropane triglycidylether (A); m-Xylylenediamine (B)

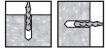
Causes severe skin burns and eye damage (A, B) May cause an allergic skin reaction (A, B) Suspected of causing genetic defects (A) May damage fertility or the unborn child (A) Toxic to aquatic life with long lasting effects (A,B)

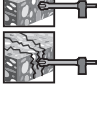









<b>en</b>	Adhesive anchoring system for rebar and anchor fastenings in concrete. Read the safety instructions, general informations and warnings before using the product.	→ 32/33
<b>de</b>	Verbundmörtel für Betoneisen- und Dübelbefestigungen in Beton. Vor der Anwendung die Sicherheitsvorschriften, die allgemeinen Informationen und die Warnhinweise lesen.	→ 34/35
<b>fr</b>	Mortier de scellement pour ancrage de chevilles et d'armatures dans le béton. Avant utilisation, bien lire les prescriptions de sécurité, les informations générales et les indications d'avertissement.	→ 36/37
<b>it</b>	Resina ad iniezione per fissaggi con tondini per cemento armato e con tasselli nel calcestruzzo. Prima di procedere all'utilizzo del prodotto, leggere le norme di sicurezza, le informazioni generali e le avvertenze.	→ 38/39
<b>es</b>	Resina de inyección para la fijación de anclajes y tacos en hormigón. Lea las indicaciones de seguridad, la información general y las advertencias antes de utilizar el producto.	→ 40/41
<b>pt</b>	Buchas químicas para fixações de ferros e de ancoragens em betão. Antes da aplicação, ler a ficha de segurança, as informações gerais e as advertências.	→ 42/43
<b>nl</b>	Ankermortel voor bevestiging van betonijzer en pluggen in beton. Vóór het gebruik de veiligheidsvoorschriften, de algemene informatie en de waarschuwingen lezen.	→ 44/45
<b>el</b>	Χημικό αγκύριο για στερεώσεις αναμονών οπλισμού και κοχλίων αγκύρωσης σε σκυρόδεμα. Πριν από τη χρήση, διαβάστε τις προδιαγραφές ασφαλείας, τις γενικές πληροφορίες και τις υποδείξεις προειδοποίησης.	→ 46/47
<b>tr</b>	Beton demiri ve dübellerin beton içerisinde sabitlenmesi için bağlantı harcı. Uygulamadan önce güvenliğin yönetmeliklerini, genel bilgileri ve uyarı bilgilerini okuyunuz.	→ 48/49
<b>cn</b>	用于在混凝土中固定钢筋和锚的胶粘剂锚固系统。使用产品前，请阅读安全说明、一般信息和警告。	→ 50/51
<b>zh</b>	用於混凝土中固定鋼筋及安卡的黏著安卡系統。使用產品前，請先閱讀安全說明、一般使用說明和警語。	→ 52/53
<b>ko</b>	콘크리트 고정용 철근 및 핀 연결 모르타르 시스템. 사용하기 전에 작업 시 안전규칙, 일반 정보 및 경고 사항을 숙독한다.	→ 54/55
<b>ar</b>	ملاط تثبيت لأعمال تثبيت أسياخ الحديد والخوابير في الخرسانة. احرص قبل الاستخدام على قراءة تعليمات الأمان والمعلومات العامة والإرشادات التحذيرية.	→ 56/57
<b>ms</b>	Sistem penambatan perekat untuk bar tetulang dan pengikatan penambatan dalam konkrit. Baca arahan keselamatan, maklumat umum dan amaran sebelum menggunakan produk.	→ 58/59
<b>vi</b>	Hệ thống neo cấy dùng keo để cứng cốt thép và neo cấy vào bê tông. Vui lòng đọc các hướng dẫn an toàn, thông tin tổng quát và cảnh báo trước khi sử dụng sản phẩm.	→ 60/61
<b>th</b>	ระบบผูกเคมีสำหรับติดยึดเหล็กเสริมและสลักในคอนกรีต โปรดอ่านคำแนะนำนำด้านความปลอดภัย ขอมูลทั่วไป และคำเตือนก่อนใช้งานผลิตภัณฑ์	→ 62/63

									
<b>1</b>			10...20 mm	60mm...10d					
<b>2</b>									
<b>3</b>						10...55 mm	60...1500 mm		
<b>4</b>									
<b>5</b>			10...20 mm	60...250 mm					
<b>6</b>									
<b>7</b>			10...40 mm	60...640 mm					
<b>8</b>									
<b>9</b>			10...20 mm	60...250 mm					
<b>10</b>					10...52 mm	60...1500 mm			
<b>11</b>									
<b>12</b>			12...32 mm	60...250 mm					
<b>13</b>									



<b>en</b>	Dry concrete	Water saturated concrete	Waterfilled borehole in concrete	Submerged borehole in concrete	Uncracked concrete	Cracked concrete
<b>de</b>	Trockener Beton	Wassergesättigter Beton	Wassergefülltes Bohrloch in Beton	Unterwasser Bohrloch in Beton	Ungerissener Beton	Gerissener Beton
<b>fr</b>	Béton sec	Béton saturé d'eau	Trou dans le béton rempli d'eau	Trou dans le béton immergé	Hormigón no fisurado	Hormigón fisurado
<b>it</b>	Calcestruzzo secco	Calcestruzzo saturo d'acqua	Foro pieno d'acqua nel calcestruzzo	Foro sott'acqua nel calcestruzzo	Calcestruzzo non fessurato	Calcestruzzo fessurato
<b>es</b>	Hormigón seco	Hormigón saturado de agua	Taladro lleno de agua en hormigón	Taladro sumergido en hormigón	Béton non lézardé	Béton lézardé
<b>pt</b>	Betão seco	Betão saturado de água	Furo em betão cheio de água	Furo de baixo de água em betão	Betão não fissurado	Betão fissurado
<b>nl</b>	Droog beton	Met water verzadigd beton	Met water gevuld boorgat in beton	Boorgat in beton onder water	Niet-gescheurd beton	Gescheurd beton
<b>el</b>	Στεγνό σκυρόδεμα	Σκυρόδεμα κορεσμένο με νερό	Οπή διάτρησης με νερό σε σκυρόδεμα	Υποβρύχια οπή διάτρησης μέσα σε σκυρόδεμα	Σκυρόδεμα χωρίς ρηγματώσεις	Σκυρόδεμα με ρηγματώσεις
<b>tr</b>	Kuru beton	Suya doyunulmuş beton	Beton içerisinde su ile doldurulmuş delik	Beton içerisinde su akıtma kanalı deliği	Çatlamamış beton	Çatlamis beton
<b>cn</b>	干混凝土	水饱和混凝土	装有水的混凝土钻孔	水下混凝土钻孔	未破裂混凝土	破裂混凝土
<b>zh</b>	乾燥混凝土	水飽和混凝土	混凝土中有充滿水的孔洞	混凝土中藏有孔洞	未破裂混凝土	破裂混凝土
<b>ko</b>	건식 콘크리트	습식 콘크리트	콘크리트 속에 물이 차 있는 천공구멍	수중 콘크리트 속 천공구멍	비균열 콘크리트	균열 콘크리트
<b>ar</b>	الخرسانة الجافة	الخرسانة المشبعة بالماء	ثقب محفور في الخرسانة ممتلئ بالماء	ثقب محفور في الخرسانة تحت الماء	الخرسانة غير المتشققة	الخرسانة المتشققة
<b>ms</b>	Konkrit kering	Konkrit ditepu air	Lubang jara diisikan air dalam konkrit	Lubang jara di bawah permukaan air dalam konkrit	Konkrit tidak retak	Konkrit retak
<b>vi</b>	Bê tông khô	Bê tông đủ nước	Lỗ khoan chứa nước trong bê tông	Lỗ khoan chìm trong bê tông	Bê tông chưa nứt	Bê tông nứt
<b>th</b>	คอนกรีตแห้ง	คอนกรีตอิม้มน้ำ	รูเจาะในคอนกรีตที่มีน้ำขัง	รูเจาะในคอนกรีตที่จมอยู่ในน้ำ	คอนกรีตส่วนที่รับแรงอัด	คอนกรีตส่วนที่รับแรงดึง

				 $t_{work}$	 $t_{cure, ini}$	 $t_{cure, full}$
en	Hammer drilling	Hollow drill bit	Diamond coring	Working time	Initial curing time	Curing time
de	Hammerbohren	Hohlbohrer	Diamantbohren	Verarbeitungszeit	Montagefestigkeit	Aushärtezeit
fr	Perçage avec percussion	Foret creux	Forage au diamant	Temps de manipulation	Stabilité du montage	Temps de durcissement
it	Foratura con percussione	Punta cava	Foratura con punta diamantata	Tempo di lavorazione	Resistenza di montaggio	Tempo di indurimento
es	Taladrado con martillo	Taladro con broca hueca y aspiración	Taladrado con diamante	Tiempo de tratamiento	Resistencia de montaje	Tiempo de fraguado
pt	Perfurar de martelo	Broca de coroa oca	Perfurar com equipamento diamantado	Tempo de trabalho	Resistência de montagem	Tempo de cura total
nl	Boorhameren	Holle boor	Diamantboren	Verwerkingstijd	Montagesterkte	Uithardingstijd
el	Κρουσική διάτρηση	Κρουσικό δράπανο	Διάτρηση με διαμάντι	Χρόνος επεξεργασίας	Αντοχή τοποθέτησης	Χρόνος εφαρμογής φορτίων
tr	Darbeli delme	Oyuk matkap ucu	Elmas delme	İşleme süresi	Montaj dayanıklılığı	Sertleşme süresi
cn	锤击钻孔	空心钻头	金刚石取芯钻孔	工作时间	初始固化时间	完全固化时间
zh	鎚擊鑽孔	空心鑽頭	鑽石鑽心鑽孔	工作時間	初部固化時間	固化時間
ko	함마 드릴링	동공드릴 비트	다이아몬드 드릴링	가공시간	설치강도	경화시간
ar	الثقب بالثق	ريشة ثقب التجاويف	الثقب الماسي	فترة التحضير	متانة التركيب	فترة التصلب
ms	Penggerudian tukul	Bit gerudi geronggang	Penerasan berlian	Masa bekerja	Masa pengawetan permulaan	Masa pengawetan
vi	Khoan bằng búa	Mũi khoan lỗ rỗng	Khoan bằng kim cương	Thời gian làm việc	Thời gian đóng cứng ban đầu	Thời gian đóng cứng hoàn toàn
th	การเจาะกระทบ	ดอกสว่านเจาะแบบกลวง	การคว้านด้วยเครื่องมือเพชร	ระยะเวลาในการทำงาน	ระยะเวลาในการแข็งตัวเริ่มต้น	ระยะเวลาในการแข็งตัว



Threaded rod                      Rebar  
Threaded sleeve

Gewindestange                      Bewehrungsseisen  
Gewindehülse

Varilla roscaada                      Barras corrugadas  
Manguito roscaado                      para armado

Asta filettata                      Ferri di armatura  
Manicotto filettato

Tige filetée                      Armature  
Douille filetée                      métallique

Barra roscaada                      Ferros de  
Casquilha roscaada                      armadura

Draadeind                      Wapeningsstaal  
Schroefmof

Βέργα με σπειρώμα                      Σίδερο οπλισμού  
Χπώνιο με σπειρώμα

Dişli çubuk                      Takviye demirleri  
Dişli manşon

全牙螺杆                      钢筋

全牙螺桿                      鋼筋  
螺紋套環

나사 로드                      철근  
나사 슬리브

القضيب الملوب                      قضبان حديد التسليح  
الجبنة المولبة

Rod berulir                      Batang  
Sarung berulir                      Penulangan

Thanh ren                      Cốt thép  
Ông lồng có ren

แท่งเกลียว                      เหล็กเส้น  
ปลอกเกลียว

- AE** Hiti Emirates L.L.C.  
Dubai Investment Park, Dubai  
Tel +971 800 44584  
Fax +971 84 8854405
- AR** Hiti Argentina S.R.L.  
Profesor Manuel Garcia  
4760, B1605 BIB - Munro  
AR-Buenos Aires  
Tel +54 11 4721 4400  
Fax +54 11 4721 4410
- AU** Hiti (Aust.) Pty. Ltd.  
Level 5, 1G Homebush Bay  
Drive Rhodes, N.S.W. 2138  
Tel +61 131 292  
Fax +61 1300 135 042
- BE** Hiti Belgium N.V./S.A.  
1424 Chaussée de Mons,  
1070 Bruxelles,  
Tel +32 2 467 7911
- BR** Hiti do Brasil Comercial Ltda.  
Al. Rio Negro, 500 -Torre A,  
9º andar  
06454-000 Barueri, SP  
Tel +55 11 4134 9000  
Fax +55 11 4134 9072
- CZ** Hiti CR spol. s r.o  
Uhrinevska 734 P.O. Box 29,  
CZ-25243 Prag-Pruhonice  
Tel +420 2 611 95 611  
Fax +420 2 726 80 440
- DZ** Hiti Construction Equipments  
EURL, 14 Lotissement  
Mehiedine Sidi Hassen,  
Cheraga, Alger  
Tel +213 23 360 599  
Fax +213 23 360 599
- ES** HITI ESPAÑOLA, S.A.  
Camino Fuente de la Mora,  
1-3a planta, ES-28050 Madrid  
Tel +34 902 10 04 75
- GB** Hiti (Gt. Britain) Ltd.,  
No 1, Circle Square,  
3 Symphony Park,  
GB-M1 7FS Manchester,  
Great Britain,  
+44 161 886 1000
- GR** HITI Ελλάς ΑΕΕ. Α. Κύριος 132  
GR-151 23 Μορούφι, Αθήνα  
Tel +30 210 288 0600  
Fax +30 210 288 0607
- HR** Hiti Croatia d.o.o.  
Ljudevita Posavskog bb  
HR-10360 Sesvete  
Tel +385 1 2030 777  
Fax +385 1 2030 766
- HU** Hiti (Hungária), Szolgáltató  
Kft., Belső út 271 4th floor  
(Fórum Office) Magyarország  
HU-1037 Budapest  
Tel +36 1 4366 300  
Fax +36 1 4366 390
- ID** P.T. Hiti Nusantara  
The Garden Center Level  
3 No. 3-11B, Kawasan  
Komersial Cilandak  
Jl. Raya Cilandak KKO  
Jakarta 12560  
Tel +62 21 789 0850  
Fax + 62 21 789 0845
- IE** Hiti (Fastening Systems)  
Limited Unit C4  
North City Business Park  
Finglas IRL-Dublin 11  
Tel +353 188 64101
- IL** Hiti (Israel) Ltd., 6 Ravinsky  
St. Ind. Zone Sgula, P.O.Box  
2650, 49125 Petach Tikva  
Tel +972 3 930 4499  
Fax +972 3 930 2095
- IN** Hiti (India) Pvt. Ltd 6th  
Floor Building 8 Tower C  
DLF Cyber City Phase-II  
Gunragum – 122 002  
Tel: 1800 102 6400
- IT** Hiti Italia S.p.a.  
Piazza Montanelli 20  
IT-20099 Sesio San Giovanni  
(Milano), Tel +39 02 212 72
- LI** Hiti (Schweiz) AG, Hiti Store  
Schaan, Im alten Riet 102,  
FL-9494 Schaan,  
T +423 232 45 30
- KR** 서울시 송파구 범포동  
11길 12 (한양타워) 7층  
135-855 서울 - Korea  
T 090-220-2000  
(수신자 부담)
- MA** Hiti Maroc, 6 Allée des  
Cypres, Ain Sebba  
MA-Casablanca  
Tel +2125 2267 58 00  
Fax +2125 2266 39 41
- MY** Hiti (Malaysia) Sdn. Bhd.  
Level 8 Brunsfield Tower 3  
No. 2 Jalan PUI 1A/7A Oasis  
Square Oasis Damansara  
47301 Petaling Jaya Selangor  
Malaysia Toll Free  
1800 880 985
- NO** Motek AS,  
Oestre Aker vei 61, Postboks  
81, Oekern, NO-0508 Oslo 5  
Tel +47 23052050  
Fax +47 22 640 063
- NZ** Hiti (New Zealand) Limited  
Level 1, Building B, 600  
Great South Rd, Auckland,  
1051, New Zealand P.O Box  
112-030, Pentrose 1642  
Tel +64 9 526 7783
- PE** Hiti Perú S.A.  
Av. Javier Prado Este No.  
499 Int. 1103, Golf los Inkas  
Santiago de Surco  
15023  
Tel +51 (0) 800 44 584
- PH** Hiti (Philippines) Inc. 9/F  
Cyberscape Beta Topaz &  
Ruby Road, Ortigas Center,  
San Antonio, 1605 City of  
Pasig T +632 784 7100  
Fax +63 2 784 7100
- PR** Hiti Caribe, LLC  
The Palmas Village #3,  
Carr. 869 KM 2,  
Palmas Industrial Park  
Cataño, PR 00982  
Tel +1-787 936-7060  
Fax +1 787 936-7065
- PT** Hiti (Portugal) Produtos e  
Servicos, Lda.,  
Rua da Lionesa, nº 446, Ed.  
C39 4465-671  
Leça do Balio,  
Tel +351 808 200 111  
Fax +351 808 222 111
- QA** Hiti Qatar W.L.L.  
Souq Al Rawda, Salwa Road,  
Doha Ad Dawhah  
Tel +974 4406 3600  
Fax +974 4406 3669
- RS** Hiti SMN doo, 11080 Zemun,  
Banatska 83C, Belgrade  
Tel +381-11-6556 896  
Fax +381-11-6556 891
- SA** Hiti Saudi Arabia for  
Construction Tools LLC, King  
Fahd Street  
P.O. Box 1340  
KSA-21454 Jeddah  
Tel +966 2 213 8400  
Fax +966 2 697 4696
- SE** Hiti Svenska AB, Hitielle  
Stationstorg 31, SE-215 32  
Malmö, Sweden, +46 40 539  
300 – Mailing: Hiti Svenska  
AB, Hitielle Boulevard 34,  
SE-215 32 Malmö, Sweden
- SG** Hiti Far East Private Ltd.  
80 Pasir Panjang Road, #16-  
83/84 Mapletree Business  
City Singapore 117372  
Tel +65 55860303
- SK** Hiti Slovakia spol. s r.o.  
Galvanho 7  
SK-82104 Bratislava  
Tel +421 248 221 211  
Fax +421 248 221 255
- SL** Hiti Slovenija d.o.o.  
Brodisce 18,  
SLO-1236 Trzin  
Tel +386 80 2522  
Fax +386 1 56371 12
- TH** บริษัท ฮิติ (ไทยแลนด์) จำกัด  
185/8/107-108 อารักษ์  
อินทพรวิจิตร ทาวเวอร์  
บางนา ชั้น 24 ถนนพหลโยธิน  
แขวงคลองเตย เขตคลองเตย  
กรุงเทพมหานคร 10260,  
T +662 099 5300
- TR** Hiti İnşaat Malz. Tic. A.Ş.  
Barbaros Mah. Çiğdem Sok.  
Agaoglu My Office Istanbul -  
Türkiye  
T +90216 44Hiti (444 4584)
- TW** 新北市板橋區新站路16  
號24樓 10060 台北 - 台灣  
T +886 2 2357 9090
- UA** Хіті (Україна) Лтд., ул.  
Хвоцькі, 15/15 04080 Киев -  
Україна T +380 44 390 5560
- VN** Hiti Vietnam Co., Ltd.,  
Ground Floor 198 Nguyen Thi  
Minh Khai Vo Thi Sau Ward  
District 3 HCMC Vietnam,  
+84 9390 4091
- ZA** Hiti (South Africa) (Pty) Ltd.  
72 Gazelle Avenue Corporate  
Park ZA-1686 Midrand  
Tel +2711 2373000

HIT-V (-R, -F, -HCR) / HAS (-R, -F, -HCR) / HAS-E (-R, -F, -HCR)

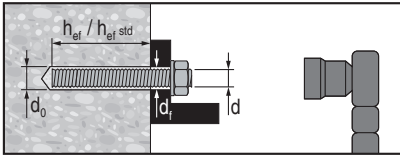

M8 - M30









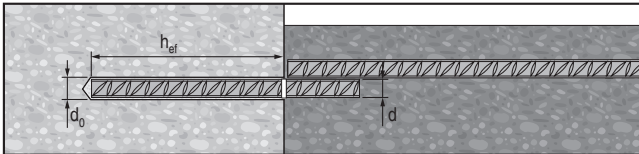



M10 - M30

 Ø d [mm]	Ø d <sub>0</sub> [mm]	h <sub>ef std</sub> [mm]	h <sub>ef</sub> [mm]	Ø d <sub>f</sub> [mm]	T <sub>inst</sub> [Nm]
M8	10	80	60...160	9	≤ 10
M10	12	90	60...200	12	≤ 20
M12	14	110	70...240	14	≤ 40
M16	18	125	80...320	18	≤ 80
M20	22	170	90...400	22	≤ 150
M24	28	210	96...480	26	≤ 200
M27	30	240	108...540	30	≤ 270
M30	35	270	120...600	33	≤ 300

Rebar







 Ø d [mm]	Ø d <sub>0</sub> [mm]	h <sub>ef</sub> [mm]
8	10 / 12	60...250/1000
10	12 / 14	60...250/1000
12	14 / 16	70...250/1200
14	18	75...1200
16	20	80...1500
18	22	85...1300
20	24/25	90...400/1300
22	28	95...1000
24	32	100...1000
25	30/32	100...500/1000
26	32	104...700
28	35	112...700
30	37	120...700
32	40	130...700
34	45	...500
36	45	...500
40	55	...500







		HIT-V HAS- 	Rebar 		Rebar 		HIT-SZ 	HIT-DL 
$d_0$ [mm]	$d_0$ [mm]	$d$ [mm]		$d_0$ [mm]	$d$ [mm]	[mm]	[mm]	[mm]
10	-	8	8	10	8	10	-	-
12	12	10	8/10	12	8/10	12	12	12
14	14	12	10/12	14	10/12	14	14	14
16	16	-	12	16	12	16	16	16
18	18	16	14	18	14	18	18	18
20	20	-	16	20	16	20	20	20
22	22	20	18	22	18	22	22	20
24	24	-	20	-	-	24	24	20
25	25	-	20	25	20	25	25	25
28	28	24	22	28	22	28	28	25
30	30	27	25	-	-	30	30	25
32	32	-	24/25/26	32	24/25	32	32	32
35	-	30	28	35	26/28/30	35	35	32
37	-	-	30	-	-	37	37	32
40	-	-	32	40	32	40	40	32
-	-	-	-	42	34	42	42	-
45	-	-	34/36	-	-	45	45	-
-	-	-	-	47	36	47	47	-
-	-	-	-	52	40	52	52	-
55	-	-	40	-	-	55	55	-

HIT-DL:  $h_{ef} > 250$  mm,  $h_{ef} > 20 \times d$



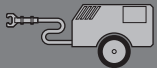









HIT-RB:  $h_{ef} > 20 \times d$



Hilti VC 20/40 (-Y) 		HIT-OHC 		HIT-OHW 
	$\emptyset d_0$ [mm]	HIT-...	Art. No.	Art. No.
min. 57 l/s	10 ... 20	OHC 1	387551	387550
	22 ... 32	OHC 2	387552	

				HIT-VL 	HIT-DL 
$\emptyset d_0$	$h_{ef}$		Art. No. 381215		
... 32 mm	60 ... 800 mm	$\geq 6$ bar @ 6 m <sup>3</sup> /h	✓	✓	✓
... 55 mm	60 ... 1500 mm	$\geq 6$ bar @ 140 m <sup>3</sup> /h	-	✓	✓



  			 		  	
	[°C]	[°F]	 $t_{\text{work}}$	 $t_{\text{cure, ini}}$	 $t_{\text{cure, full}}$	
	5...9	41 ... 49	0...2 h	≥ 18 h	≥ 72 h	
	10...14	50 ... 58	0...1½ h	≥ 12 h	≥ 48 h	
	15...19	59 ... 67	0...30 min	≥ 8 h	≥ 24 h	
	20...29	68 ... 85	0...20 min	≥ 6 h	≥ 12 h	
	30...39	86 ... 103	0...12 min	≥ 4 h	≥ 8 h	
	40	104	0...12 min	≥ 2 h	≥ 4 h	



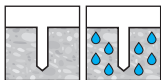
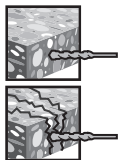

 = 2x  $t_{\text{cure}}$

1

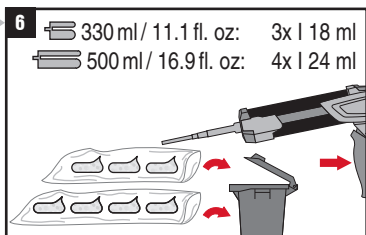
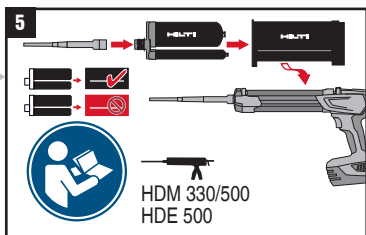
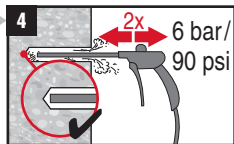
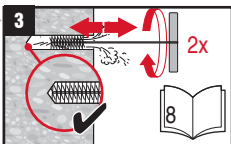
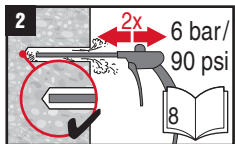
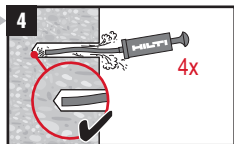
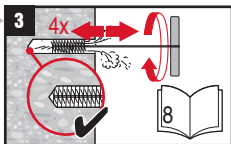
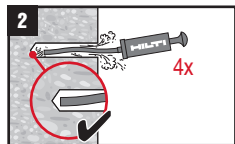
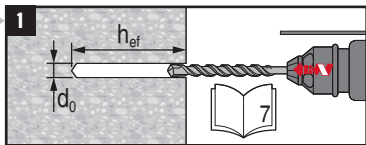
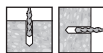

$d_0$ :  
10...20 mm

$h_{ef}$ :  
60mm...10d



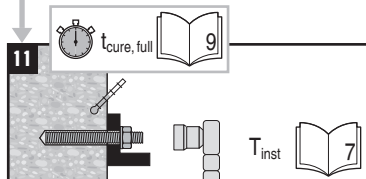
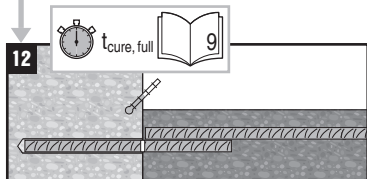
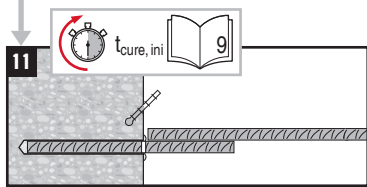
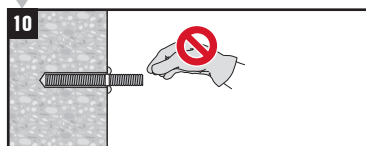
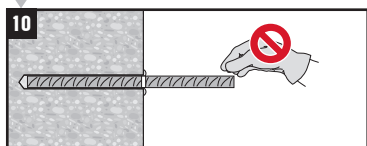
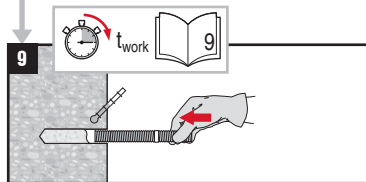
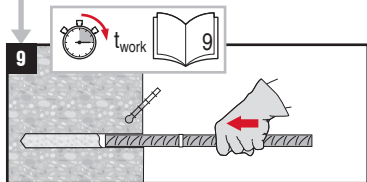
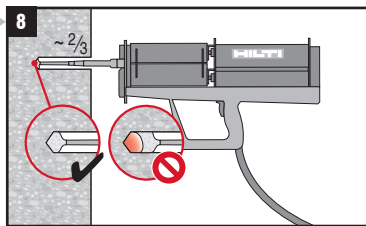
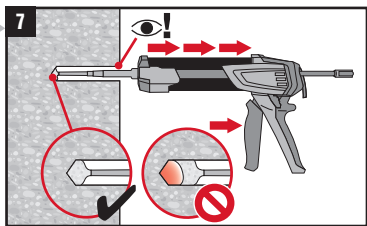

2

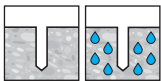
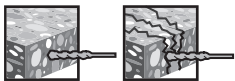

$d_0$ :  
10...20 mm

$h_{ef}$ :  
60mm...10d

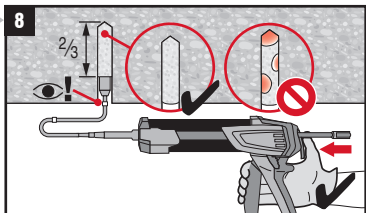
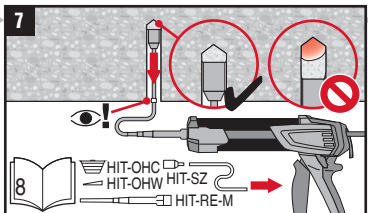
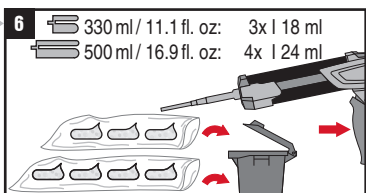
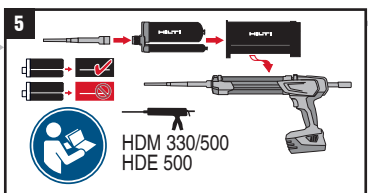
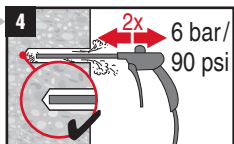
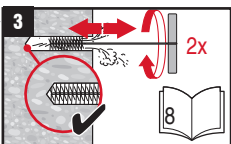
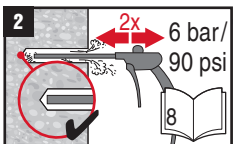
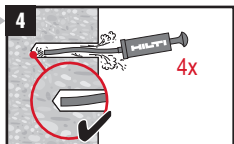
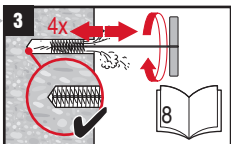
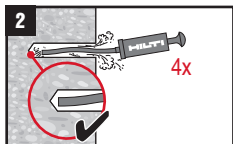
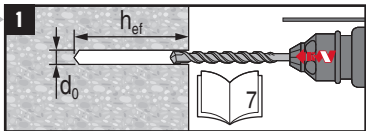

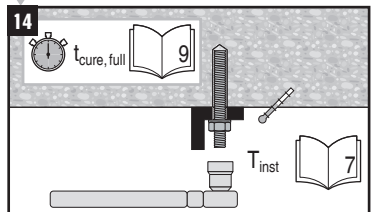
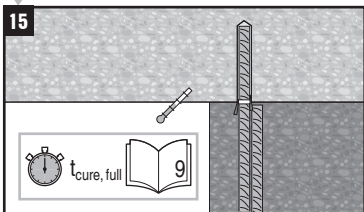
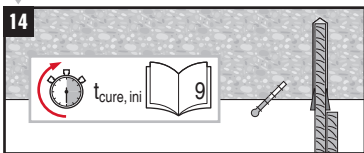
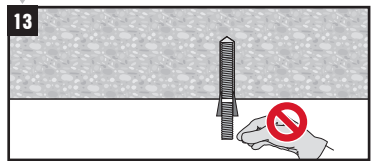
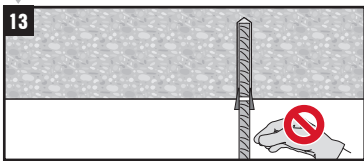
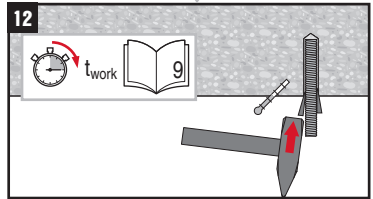
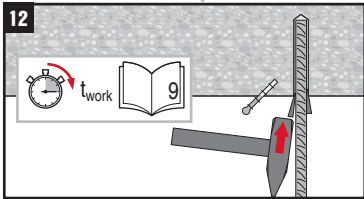
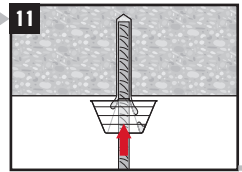
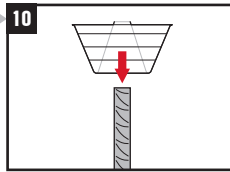
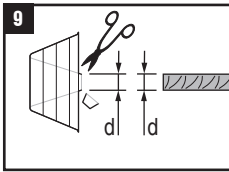

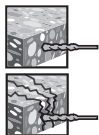
**3**

$d_0$ :  
10...55 mm

$h_{ef}$ :  
60...1500 mm

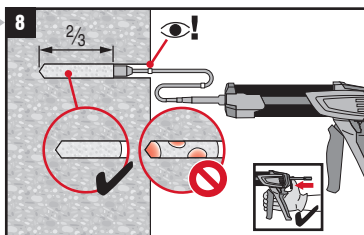
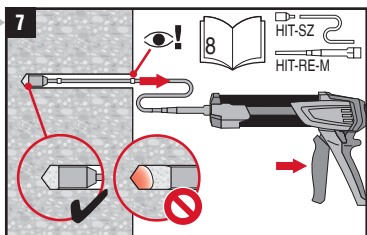
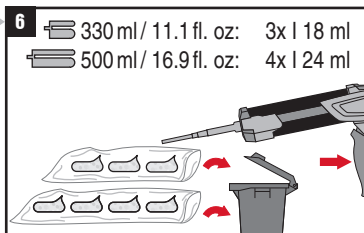
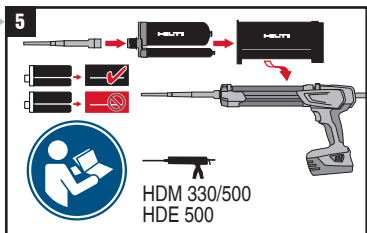
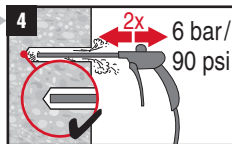
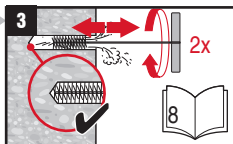
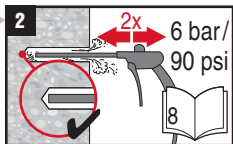
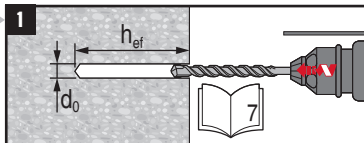
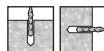

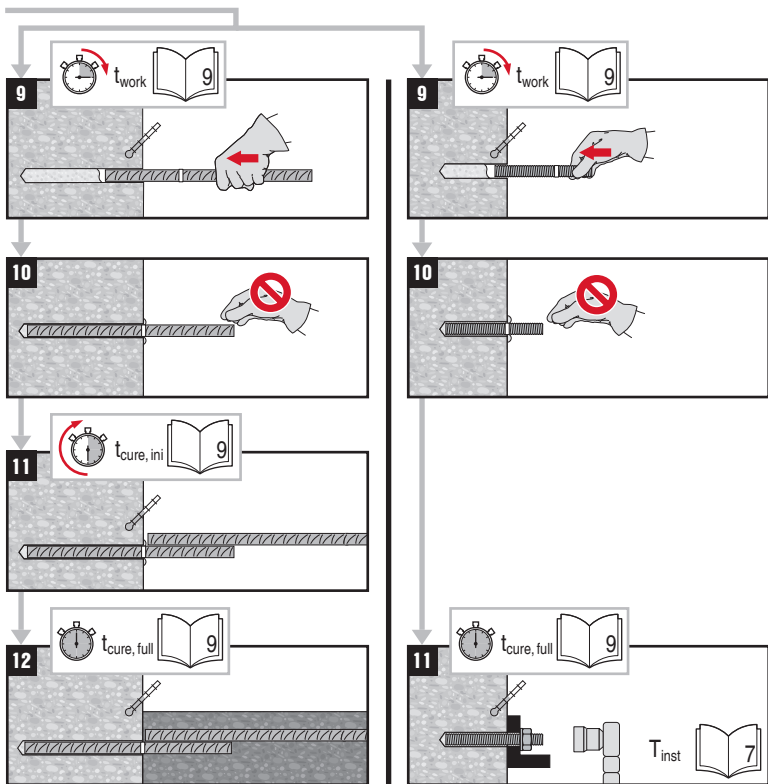

4

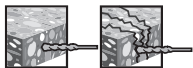

$d_0$ :  
10...55 mm

$h_{ef}$ :  
60...1500 mm

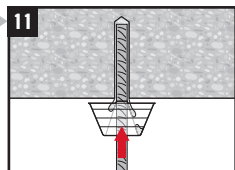
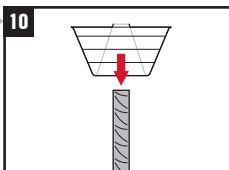
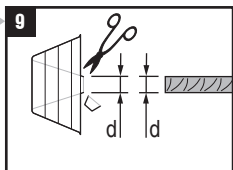
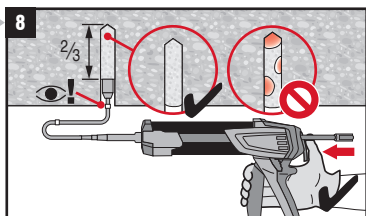
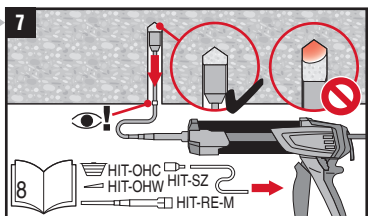
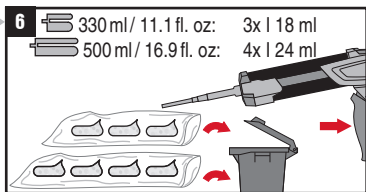
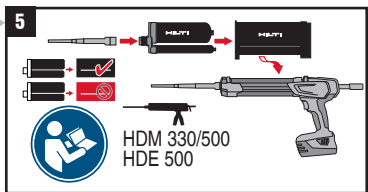
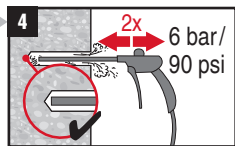
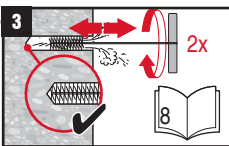
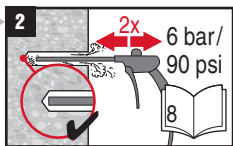
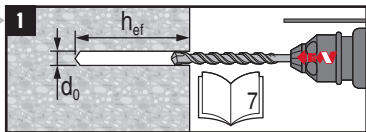



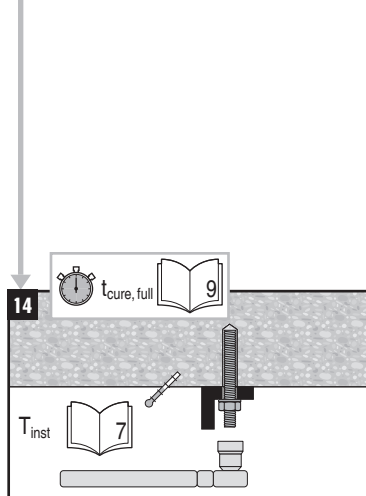
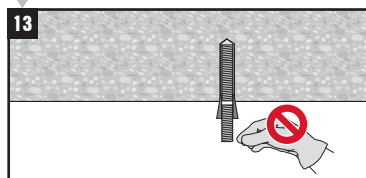
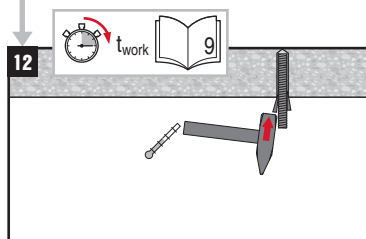
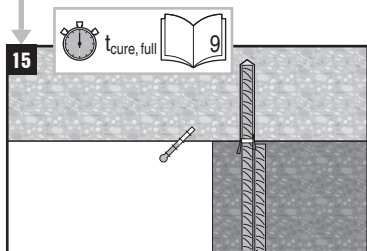
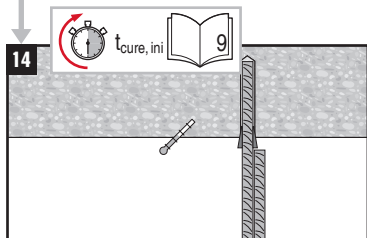
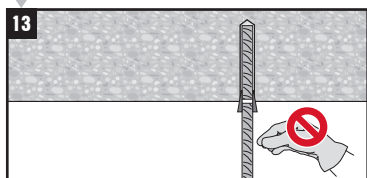
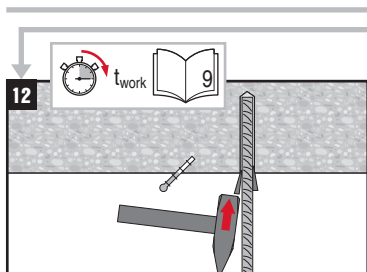

<b>5</b>			$d_0:$	$h_{ef}:$	
<b>8</b>			10...20 mm	60...250 mm	

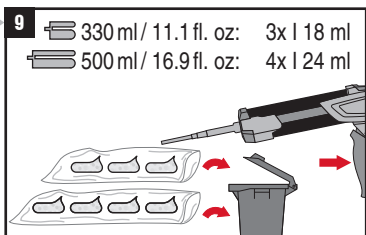
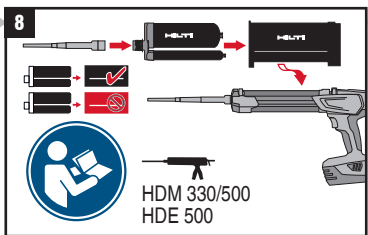
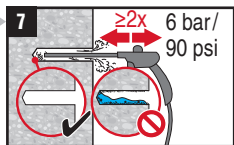
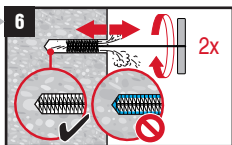
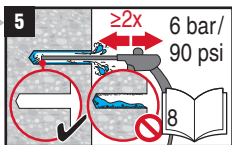
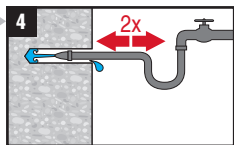
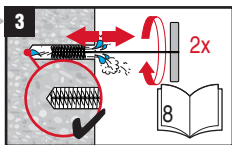
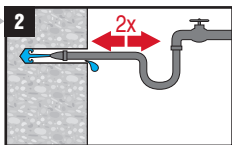
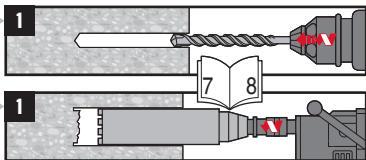

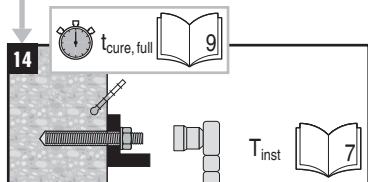
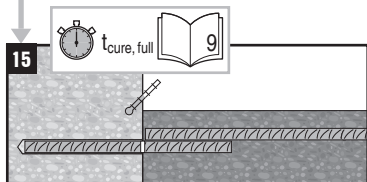
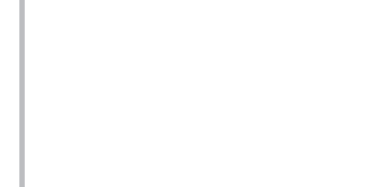
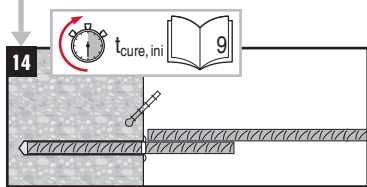
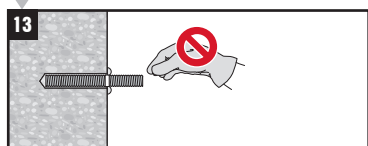
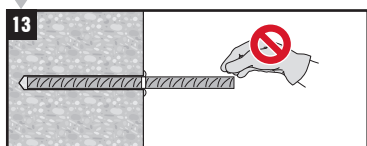
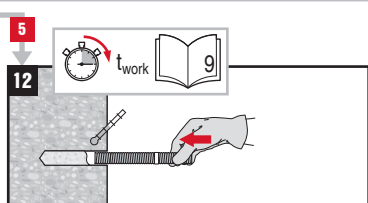
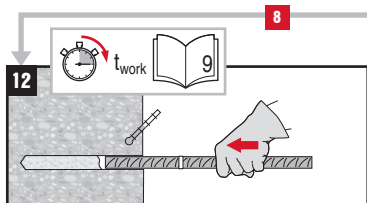
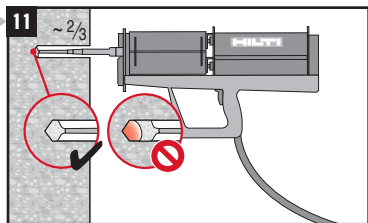
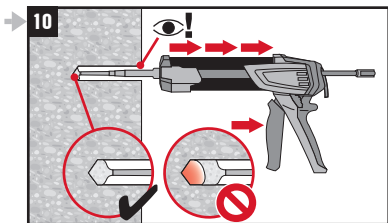

<b>6</b>			$d_0:$ 10...40 mm	$h_{ef}:$ 60...640 mm	
<b>9</b>			$d_0:$ 10...52 mm	$h_{ef}:$ 60...1500 mm	

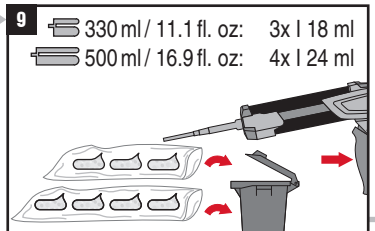
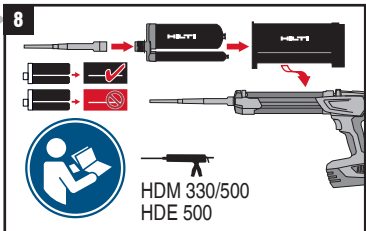
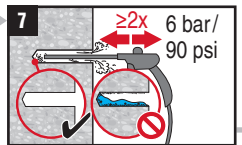
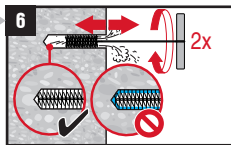
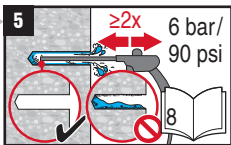
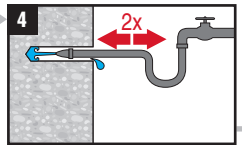
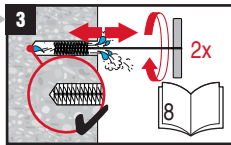
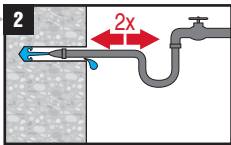
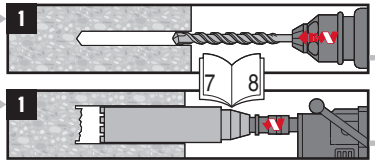

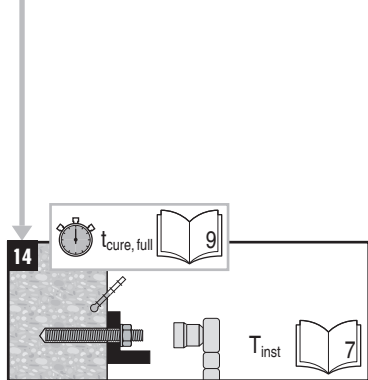
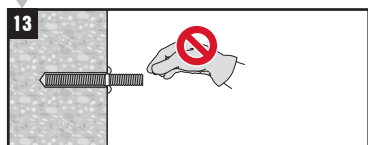
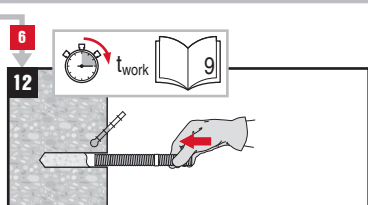
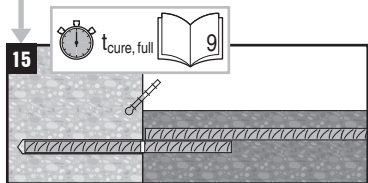
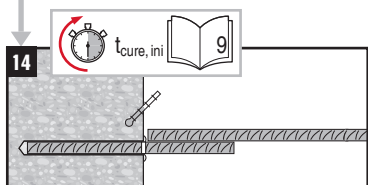
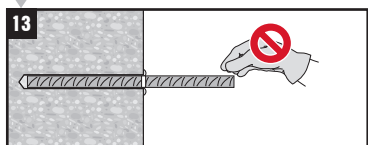
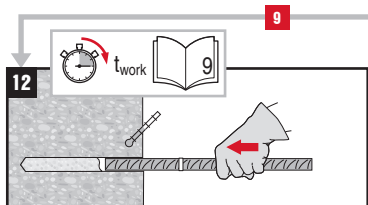
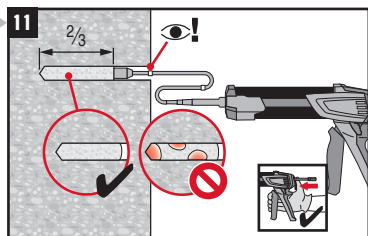
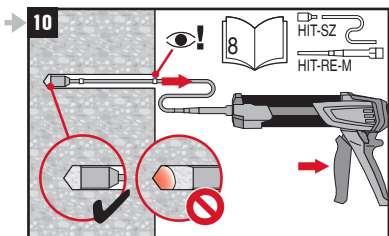

7

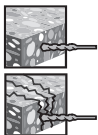

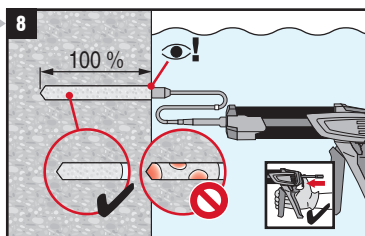
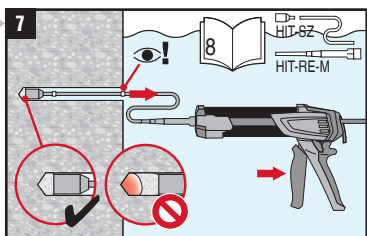
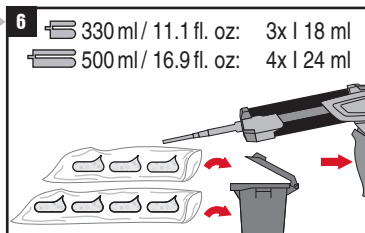
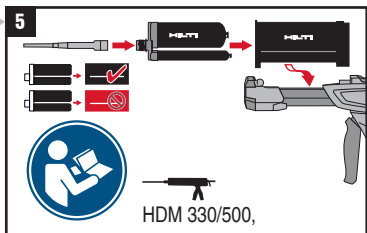
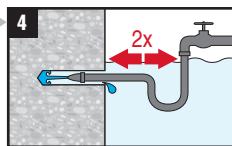
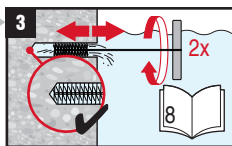
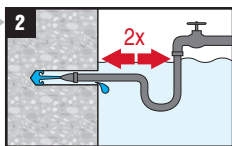
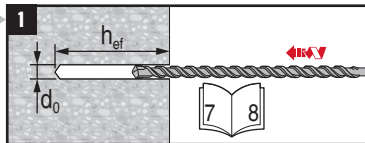
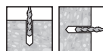
 $d_0$ :  
10...40 mm

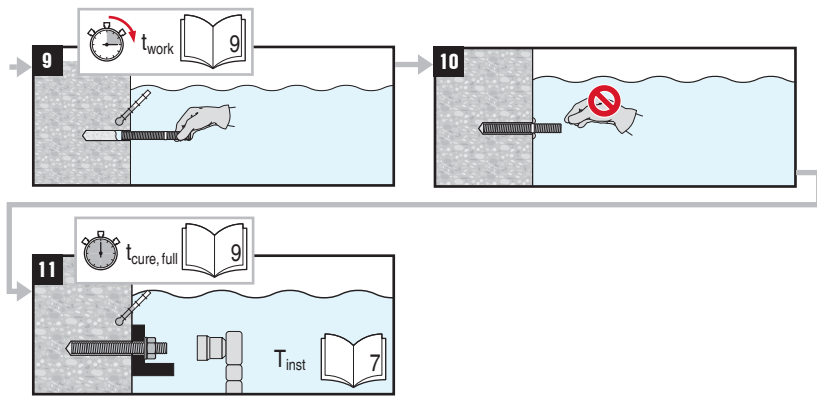
 $h_{ef}$ :  
60...640 mm



10

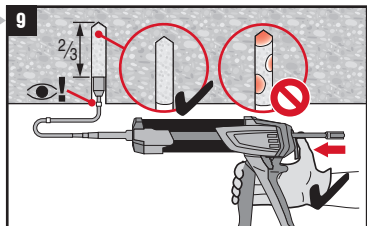
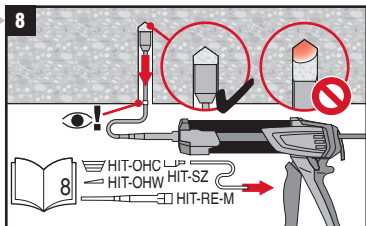
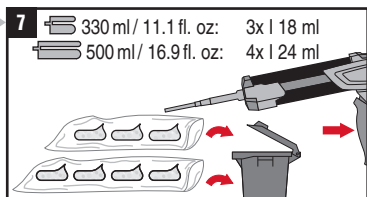
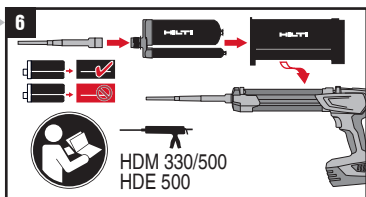
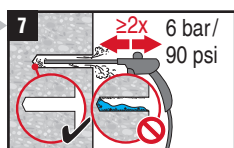
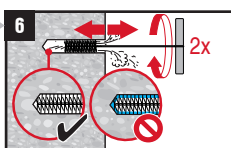
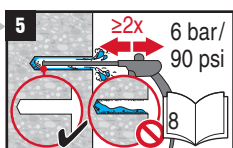
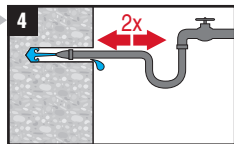
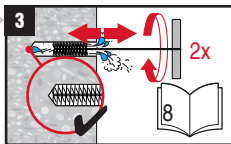
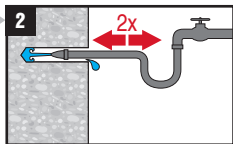
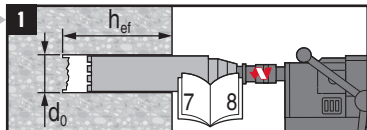

 $d_0$ :  
10...52 mm

 $h_{ef}$ :  
60...1500 mm

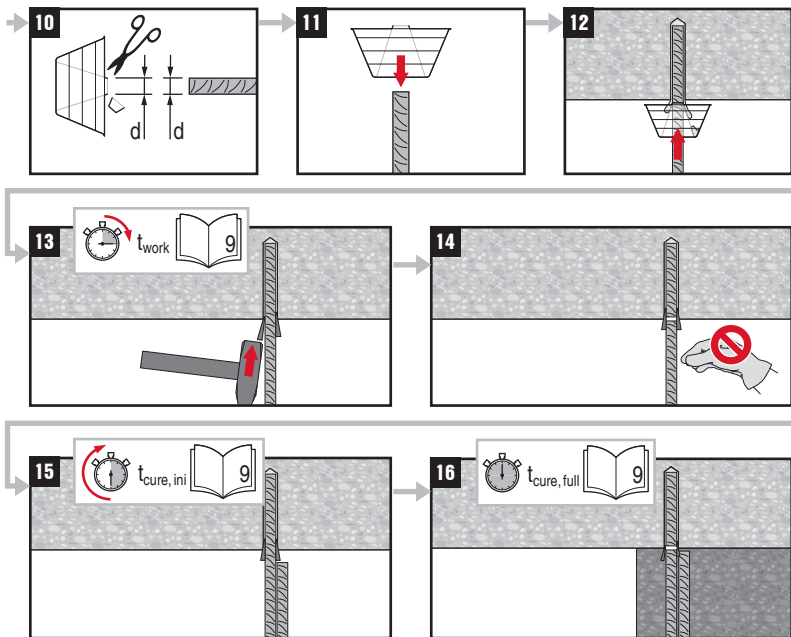

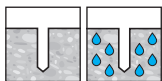
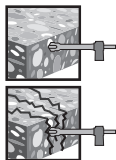

11



$d_0$ :  
12...32 mm

$h_{ef}$ :  
60...250 mm

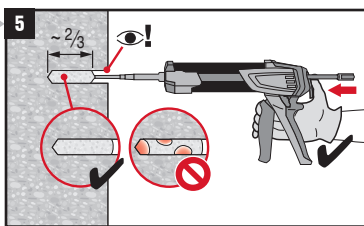
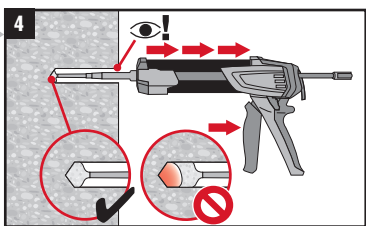
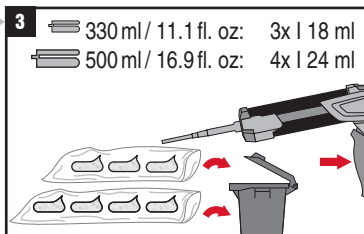
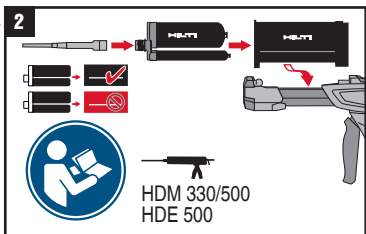
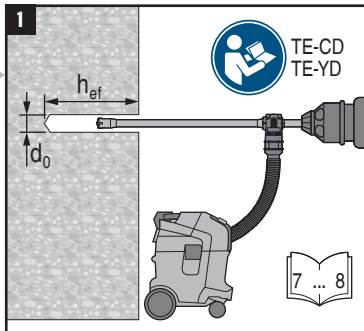
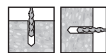

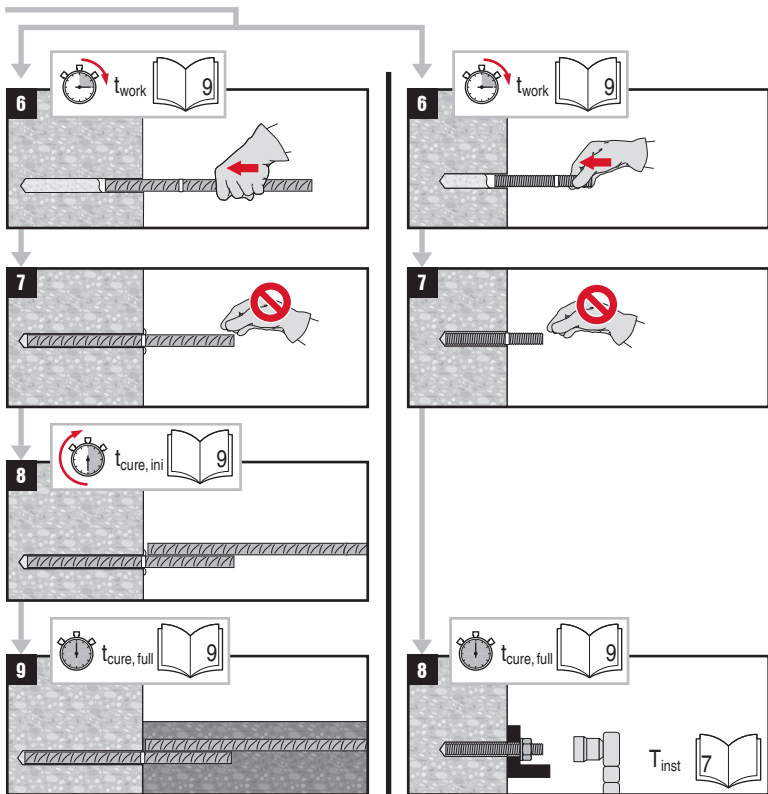

12

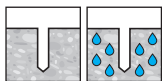
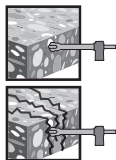

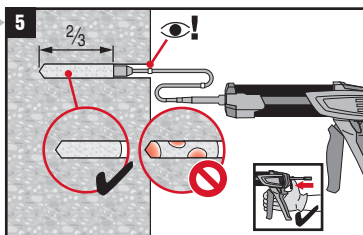
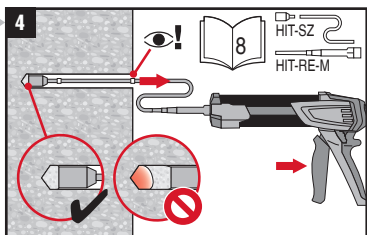
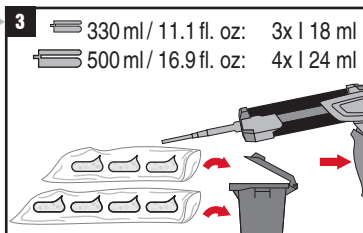
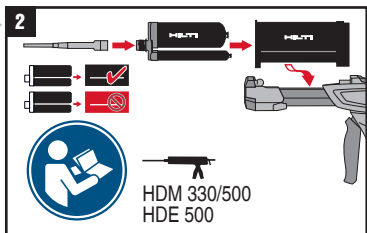
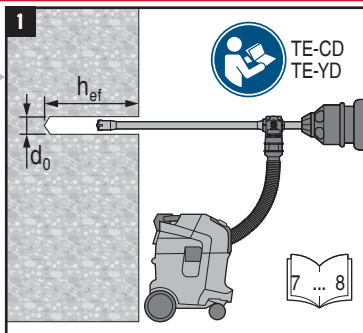
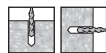
 $d_0$ :  
12...32 mm

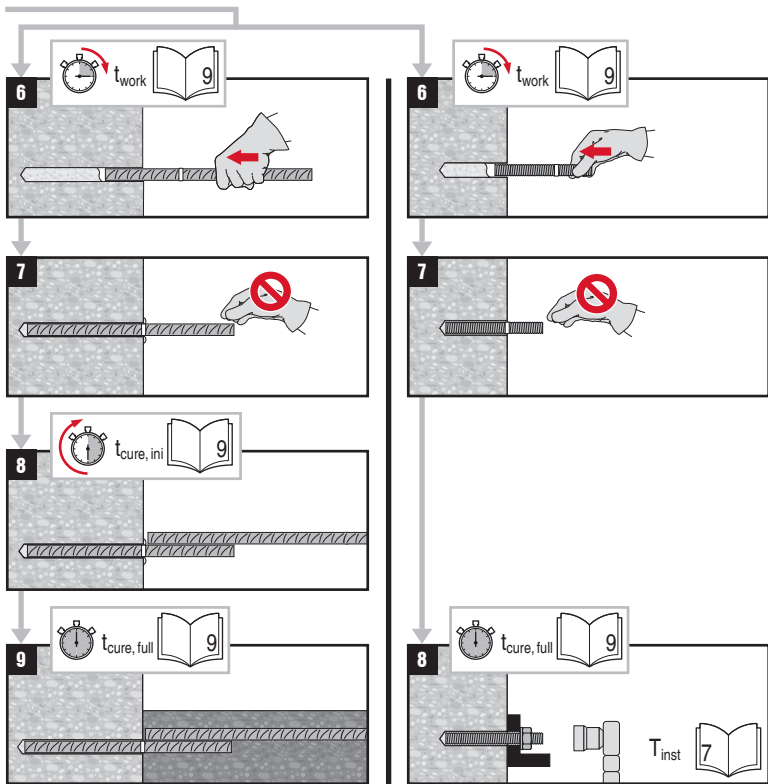
 $h_{ef}$ :  
60...1000 mm

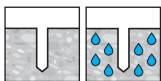
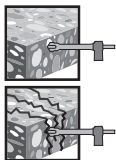

13

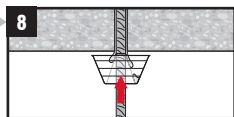
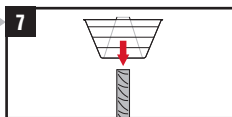
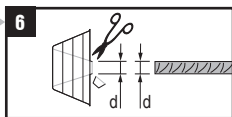
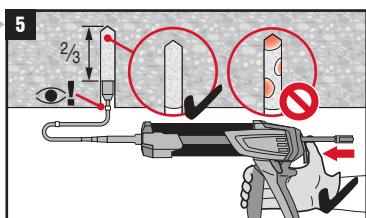
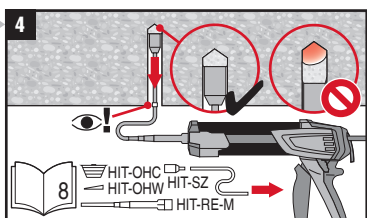
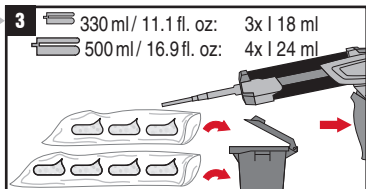
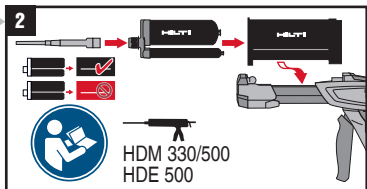
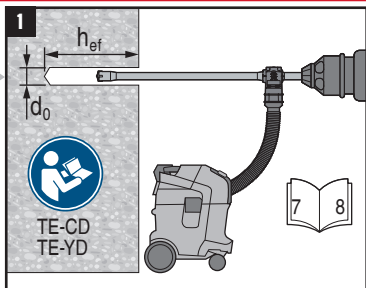
 $d_0$ :  
12...32 mm

 $h_{ef}$ :  
60...1000 mm

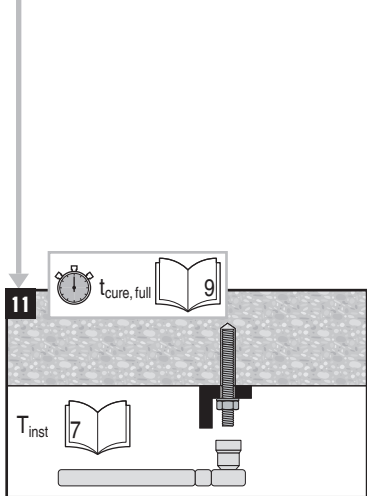
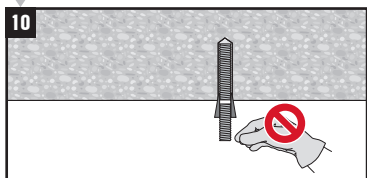
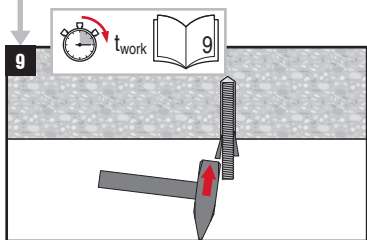
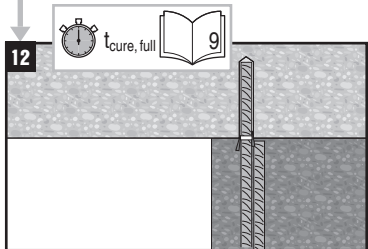
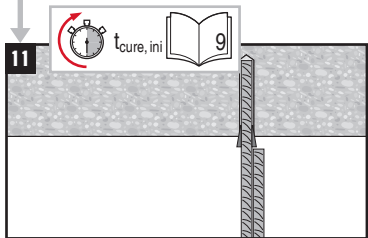
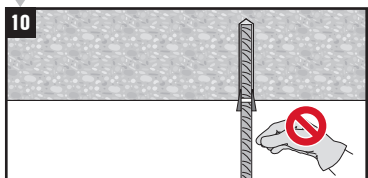
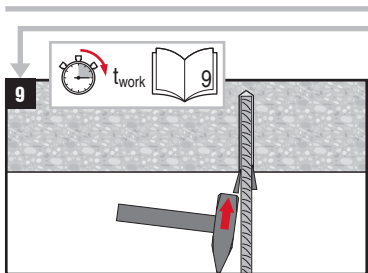

## Adhesive anchoring system for rebar and anchor fastenings in concrete

► Prior to use of product, follow the instructions for use and the legally obligated safety precautions.

### Hilti HIT-RE 100

**Contains:** 2,2'-[(1-methylethylidene)bis(4,1-phenyleneoxymethylene)]bisoxirane (A); Formaldehyde, oligomeric reaction products with 1-chloro-2,3-epoxypropane and phenol (A); Trimethylolpropane triglycidylether (A); m-Xylylenediamine (B);



(A,B)



(A,B)



(A)



(A)



### Danger

H314	Causes severe skin burns and eye damage.(A,B)
H317	May cause an allergic skin reaction.(A,B)
H341	Suspected of causing genetic defects. (A)
H360	May damage fertility or the unborn child (A)
H411	Toxic to aquatic life with long lasting effects.(A,B)

P280 Wear protective gloves/protective clothing/eye protection/face protection.

P262 Do not get in eyes, on skin, or on clothing

P302+P352 IF ON SKIN: Wash with plenty of soap and water.

P305+P351+P338 IF IN EYES: Rinse cautiously with water for several minutes. Remove contact lenses, if present and easy to do. Continue rinsing.

P333+P313 If skin irritation or rash occurs: Get medical advice/attention.

P337+P313 If eye irritation persists: Get medical advice/attention.

### Recommended protective equipment:

**Eye protection:** Tightly sealed safety glasses e.g.: #02065449 Safety glasses PP EY-CA NCH clear; #02065591 Goggles PP EY-HA R HC/AF clear;

**Protective gloves:** EN 374 / EN 388; Material of gloves: Nitrile rubber, NBR Avoid direct contact with the chemical/ the product/ the preparation by organizational measures.

**Final selection of appropriate protective equipment is in the responsibility of the user**

### Disposal considerations

#### Empty packs:

► EAK waste material code 15 01 02 plastic packaging.

#### Full or partially emptied packs:

► dispose of as special waste in accordance with official regulations.

– EAK waste material code: 20 01 27\* paint, inks, adhesives and resins containing dangerous substances.

– or waste material code: EAK 08 04 09\* waste adhesives and sealants containing organic solvents or other dangerous substances.

**Content:** 330 ml / 11.1 fl. oz

500 ml / 16.9 fl. oz

**Weight:** 475g / 16.7 oz

723g / 25.5 oz



Hilti accepts no liability for damage or failure caused by:

- Storage and transport not in accordance with the specified conditions.
- Failure to observe the instructions for use and setting data, incorrect use
- Inadequate design of the anchor points, inadequate load bearing capacity of the base material
- Other influences of which Hilti is not aware or on which Hilti has no influence, e.g. use with products from a third party.

## Product Information

- Always keep this instruction for use together with the product.
- Ensure that the instruction for use is with the product when it is given to other persons.
- Safety Data Sheet: Review the SDS before use.
- Check expiration date: See expiration date imprint on foilpack manifold (month/year). Do not use expired product.
- Foil pack temperature during usage: +5 °C to 40 °C / 41 °F to 104 °F.
- Conditions for transport and storage: Keep in a cool, dry and dark place between +5 °C to 25 °C / 41 °F to 77 °F.
- For any application not covered by this document / beyond values specified, please contact Hilti.
- Partly used foil packs must remain in the cassette and used up within 4 weeks. Leave the mixer attached on the foil pack manifold and store under the recommended storage conditions. If reused, attach a new mixer and discard the initial quantity of anchor adhesive.

### WARNING



#### **▲ Improper handling may cause mortar splashes. Eye contact with mortar may cause irreversible eye damage!**

- Always wear tightly sealed safety glasses, gloves and protective clothes before handling the mortar!
- Never start dispensing without a mixer properly screwed on.
- Attach a new mixer prior to dispensing a new foil pack (snug fit).
- Caution! Never remove the mixer while the foil pack system is under pressure. Press the release button of the dispenser to avoid mortar splashing.
- When using an extension hose: Discard of initial mortar flow must be done through supplied mixer only (not through the extension hose).
- Use only the mixer supplied with the adhesive. Do not modify the mixer in any way.
- Never use damaged foil packs and/or damaged or unclean foil pack holders.

#### **▲ Poor load values / potential failure of fastening points due to inadequate borehole cleaning.**

- Hilti hollow drill bits TE-CD, TE-YD must be used in conjunction with a properly maintained Hilti vacuum cleaner with model and suction capacity (volumetric flow rate) as specified in the accessory table
- The boreholes must be dry and free of debris, dust, water, ice, oil, grease and other contaminants prior to adhesive injection.
- For blowing out the borehole - blow out with oil free air until return air stream is free of noticeable dust.
- For brushing only use specified wire brush. The brush must resist insertion into the borehole - if not the brush is too small and must be replaced.
- For flushing the borehole - flush with water line pressure until water runs clear.
- Important! Remove all water from the borehole and blow out with oil free compressed air until borehole is completely dried before mortar injection (not applicable to hammer drilled hole in underwater application).

#### **▲ Ensure that boreholes are filled from the back of the boreholes without forming air voids.**

- If necessary, use the accessories / extensions to reach the back of the borehole.
- For overhead applications use the overhead accessories HIT-SZ / IP and take special care when inserting the fastening element. Excess adhesive may be forced out of the borehole. Make sure that no mortar drips onto the installer.
- If a new mixer is installed onto a previously-opened foil pack, the first trigger pulls must be discarded.
- A new mixer must be used for each new foil pack.

#### **▲ Not adhering to these setting instructions can result in failure of fastening points!**

## Verbundmörtel für Betoneisen- und Dübelbefestigungen in Beton

► Vor der Verwendung diese Gebrauchsanleitung lesen und die Sicherheitsvorschriften einhalten.

### Hilti HIT-RE 100

**Enthält:** Reaktionsprodukt: 2,2-Bis(4-hydroxyphenyl)propan-bis(2,3-epoxypropyl)ether (A); Formaldehyde, oligomeric reaction products with 1-chloro-2,3-epoxypropane and phenol (A); Trimethylolpropane triglycidylether (A); m-Xylylenediamin (B);



### Gefahr

- H314 Verursacht schwere Verätzungen der Haut und schwere Augenschäden.(A, B)  
H317 Kann allergische Hautreaktionen verursachen.(A,B)  
H341 Kann vermutlich genetische Defekte verursachen. (A)  
H360 Kann die Fruchtbarkeit beeinträchtigen oder das Kind im Mutterleib schädigen (A)  
H411 Giftig für Wasserorganismen, mit langfristiger Wirkung.(A,B)

P280 Schutzhandschuhe/Schutzkleidung/Augenschutz/Gesichtsschutz tragen.

P262 Nicht in die Augen, auf die Haut oder auf die Kleidung gelangen lassen

P302+P352 BEI KONTAKT MIT DER HAUT: Mit viel Wasser und Seife waschen

P305+P351+P338 BEI KONTAKT MIT DEN AUGEN: Einige Minuten lang behutsam mit Wasser spülen. Vorhandene Kontaktlinsen nach Möglichkeit entfernen. Weiter spülen.

P333+P313 Bei Hautreizung oder -ausschlag: Ärztlichen Rat einholen/ärztliche Hilfe hinzuziehen.

P337+P313 Bei anhaltender Augenreizung: Ärztlichen Rat einholen/ärztliche Hilfe hinzuziehen

### Empfehlung zur persönlichen Schutzausrüstung

**Augenschutz:** Dichtschließende Schutzbrille z.B.: #02065449 Sicherheitsbrille PP EY-CA NCH klar; #2065591 Schutzbrille PP EY-HA R HC/AF klar;

**Handschutz:** EN 374 / EN 388; Ein Direktkontakt mit der Chemikalie / dem Produkt / der Zubereitung ist durch organisatorische Maßnahmen zu vermeiden.

**Die endgültige Auswahl der geeigneten Schutzausrüstung liegt in der Verantwortung des Anwenders.**

### Hinweise zur Entsorgung

#### Entleerte Gebinde

► EAK-Abfallcode: 15 01 02 Verpackungen aus Kunststoff.

#### Volle / teilentleerte Gebinde:

- Unter Beachtung der behördlichen Vorschriften als Sonderabfall entsorgen.
- EAK-Abfallcode: 20 01 27\* Farben, Druckfarben, Klebstoffe und Kunstharze, die gefährliche Stoffe enthalten.
  - oder EAK-Abfallcode: 08 04 09\* Klebstoff- und Dichtmassenabfälle, die organische Lösemittel oder andere gefährliche Stoffe enthalten.

**Inhalt:** 330 ml / 11.1 fl. oz

500 ml / 16.9 fl. oz

**Gewicht:** 475g / 16.7 oz

723g / 25.5 oz

Hilti übernimmt keine Haftung für Schäden verursacht durch:

- von den Vorschriften abweichende Lagerungs- und Transportbedingungen
- Missachtung der Gebrauchsanweisung und der Setzdaten, fehlerhafte Anwendung
- nicht ausreichende Bemessung der Verankerung, ungenügende Tragfähigkeit des Untergrundes
- andere Einflüsse, die Hilti nicht bekannt oder von Hilti nicht zu vertreten sind, wie z.B. die Verwendung von Dritprodukten.

## Produktinformation

- Bewahren Sie diese Gebrauchsanweisung immer zusammen mit dem Produkt auf.
- Geben Sie das Produkt nur zusammen mit der Gebrauchsanweisung an andere Personen weiter.
- Sicherheitsdatenblatt: Vor der Arbeit das Sicherheitsdatenblatt beachten.
- Haltbarkeitsdatum: Das Haltbarkeitsdatum (Monat/Jahr) auf dem Verbindungsteil des Gebindes prüfen. Produkt darf nach Ablauf nicht mehr verwendet werden.
- Gebindetemperatur während des Gebrauchs: +5 °C bis 40 °C / 41 °F bis 104 °F.
- Transport- und Lagerungsbedingungen: Kühl, trocken und dunkel bei +5°C bis 25°C / 41°F bis 77°F.
- Bei Anwendungen, die nicht in vorliegender Gebrauchsanweisung beschrieben werden oder außerhalb der Spezifikationen liegen, wenden Sie sich bitte an Hilti.
- Nicht vollständig aufgebrauchte Foliengebände müssen in der Kassette verbleiben und innerhalb von vier Wochen weiterverwendet werden. Den Mischer aufgeschraubt lassen und das Gebinde vorschriftsmäßig lagern. Bei Weiterverwendung einen neuen Mischer aufschrauben und den Mörtelvorlauf verwerfen.

## WARNUNG



### **⚠ Bei ungemäßer Handhabung ist Spritzen des Mörtels möglich. Augenkontakt mit dem Mörtel kann bleibende Augenschäden verursachen!**

- Bei der Arbeit eine dicht schließende Schutzbrille, Schutzhandschuhe und Arbeitskleidung tragen!
- Nie ohne aufgeschraubten Mischer mit dem Auspressen beginnen!
- Vor dem Auspressen eines neuen Foliengebundes einen neuen Mischer aufschrauben. Auf festen Sitz achten.
- Vorsicht! Niemals den Mischer abschrauben, wenn das System unter Druck steht. Vorher die Entriegelungstaste am Gerät drücken, um Mörtelspritzen zu vermeiden.
- Beim Einsatz eines Verlängerungsschlauchs: Mörtelvorlauf nur durch den gelieferten Mischer verwerfen (nicht durch den Verlängerungsschlauch).
- Ausschließlich den mit dem Mörtel gelieferten Mischertyp verwenden. Den Mischer unter keinen Umständen verändern.
- Niemals beschädigte Foliengebände und / oder beschädigte oder verschmutzte Kassetten verwenden.

### **⚠ Schlechte Haltewerte / Versagen der Befestigung durch unzureichende Bohrlochreinigung.**

- Die Hilti Hohlbohrer TE-CD und TE-YD müssen in Verbindung mit einem fachgerecht gewarteten Hilti Staubsauger eingesetzt werden. Angaben zu geeigneten Modellen und zur Saugleistung (Volumenstrom) entnehmen Sie der Zubehörtabelle.
- Vor der Injektion müssen die Bohrlöcher trocken und frei sein von Bohrklein, Staub, Wasser, Eis, Öl, Fett oder anderen Verunreinigungen.
- Ausblasen des Bohrlochs – das Bohrloch mit ölfreier Luft ausblasen, bis die rückstömende Luft staubfrei ist.
- Ausbürsten des Bohrlochs – nur mit passender Stahlbürste. Beim Ausbürsten des Bohrlochs soll an der Bürste ein Widerstand zu spüren sein
- Ausspülen des Bohrlochs – mit Wasserschlauch bei normalem Leitungsdruck ausspülen bis klares Wasser abfließt.
- Wichtig! Vor dem Verfüllen mit Mörtel das Wasser aus dem Bohrloch entfernen und mit ölfreier Druckluft ausblasen, bis es vollständig trocken ist (nicht anwendbar bei hammergebohrten Bohrlochern in der Unterwasser-Anwendung).

### **⚠ Sicherstellen, dass die Bohrlochverfüllung vom Bohrlochgrund aus erfolgt, damit keine Luftblasen gebildet werden.**

- Wenn notwendig dafür die Verlängerungen verwenden, um den Bohrlochgrund zu erreichen.
- Bei Überkopf-Anwendungen das Zubehör HIT-SZ/IP verwenden und besonders beim Einführen des Befestigungselementes aufpassen. Überschüssiger Mörtel kann aus dem Bohrloch austreten. Sicherstellen, dass kein Mörtel auf den Anwender tropft.
- Wird ein neuer Mischer auf ein bereits geöffnetes Foliengebände aufgeschraubt, die ersten Hübe ebenfalls verwerfen.
- Für jedes neue Foliengebände einen neuen Mischer verwenden.

### **⚠ Nichtbeachtung der Anweisungen kann zum Versagen der Befestigung führen!**

## Mortier de scellement pour ancrage de chevilles et d'armatures dans le béton

▶ Avant toute utilisation, bien lire le présent mode d'emploi ainsi que les directives de sécurité qui y sont mentionnées.

### Hilti HIT-RE 100

**Contient:** produit de réaction: 2,2-bis[p-(2,3-époxypropoxy)phényl]propane (A); Formaldéhyde, oligomeric reaction products with 1-chloro-2,3-epoxypropane and phenol (A); Triméthylolpropane triglycidylether (A); 1,3-Benzènediméthanimine (B);



(A,B)



(A,B)



(A)



(A)



### Danger

H314	Provoque des brûlures de la peau et des lésions oculaires graves.(A,B)
H317	Peut provoquer une allergie cutanée.(A,B)
H341	Susceptible d'induire des anomalies génétiques. (A)
H360	Peut nuire à la fertilité ou au fœtus (A)
H411	Toxique pour les organismes aquatiques, entraîne des effets néfastes à long terme.(A,B)
P280	Porter des gants de protection/des vêtements de protection/un équipement de protection des yeux/du visage.
P262	Éviter tout contact avec les yeux, la peau ou les vêtements
P302+P352	EN CAS DE CONTACT AVEC LA PEAU: laver abondamment à l'eau et au savon.
P305+P351+P338	EN CAS DE CONTACT AVEC LES YEUX: rincer avec précaution à l'eau pendant plusieurs minutes. Enlever les lentilles de contact si la victime en porte et si elles peuvent être facilement enlevées.Continuer à rincer.
P333+P313	En cas d'irritation ou d'éruption cutanée: consulter un médecin.
P337+P313	Si l'irritation oculaire persiste: consulter un médecin.

### Équipement de protection recommandé :

**Protection des yeux :** Lunettes de protection hermétiques p. ex. : réf. 02065449 Lunettes de sécurité PP EY-CA NCH claires ; réf. 02065591 Masque de protection PP EY-HA R HC/AF clair ;

**Protection des mains :** EN 374 / EN 388 Éviter un contact direct avec le produit chimique / le produit / la préparation à l'aide de mesures d'organisation.

**Le choix final de l'équipement de protection adéquat relève de la seule responsabilité de l'utilisateur.**

### Indications de recyclage

#### Emballages vides

▶ code déchets EAK :15 01 02 Emballages en plastique.

#### Emballages pleins/à moitié vides :

- ▶ Les apporter à un centre de collecte des matières dangereuses conformément aux dispositions administratives.
  - Code déchets EAK : 20 01 27\* Peintures, encres d'impression, colles et résines artificielles, contenant des substances dangereuses.
  - ou code déchets EAK : 08 04 09\* Résidus de colles et composants pour joints, contenant des solvants organiques ou d'autres substances dangereuses.

**Contenu :** 330 ml / 11.1 fl. oz      500 ml / 16.9 fl. oz

**Poids :** 475g / 16.7 oz      723g / 25.5 oz

Hilti rejette toute responsabilité en cas de dommages dus :

- à des conditions de stockage et de transport non conformes aux consignes
- au non-respect du mode d'emploi et des données de pose, à une erreur d'utilisation
- à un dimensionnement insuffisant de l'ancrage, à une capacité de charge insuffisante du matériau support
- ou à tous autres facteurs non connus de Hilti ou indépendants de sa volonté, par exemple en cas d'utilisation de produits d'autres marques.

## Information produit

- Le présent mode d'emploi doit toujours être conservé avec le produit.
- Ne pas donner le produit à un autre utilisateur sans lui fournir le mode d'emploi.
- Données de sécurité : Avant toute utilisation, prendre connaissance des informations de sécurité sur les matériaux.
- Date de péremption : Contrôler la date de péremption (mois/année) imprimée sur le raccord de la cartouche. Ne plus utiliser un produit dont la date de péremption est dépassée.
- Température des recharges en cours d'utilisation : de +5 °C à 40 °C / 41 °F à 104 °F.
- Conditions de transport et de stockage : dans un endroit frais, sec et à l'abri de la lumière à une température de +5 °C à 25 °C / 41 °F à 77 °F.
- En cas d'applications qui ne sont pas décrites dans le présent mode d'emploi ou hors plage de valeurs spécifiées, s'adresser à Hilti.
- Les cartouches souples entamées doivent rester dans le porte-cartouches et être réutilisées dans les quatre semaines. Laisser la buse mélangeuse vissée sur la recharge entamée et stocker la recharge conformément à la réglementation. Avant réutilisation, visser une nouvelle buse mélangeuse et jeter le mortier extrudé lors des premières pressions.

## AVERTISSEMENT



### En cas de manquement non conforme, il y a risque de projection du mortier. Tout contact des yeux avec le mortier peut entraîner des lésions irréversibles !

- Lors du travail, porter une protection des yeux étanche, des gants et des vêtements de protection !
- Ne jamais commencer l'extrusion si la buse mélangeuse n'est pas vissée !
- Avant de commencer l'extrusion d'une nouvelle cartouche souple, visser une nouvelle buse mélangeuse. Vérifier qu'elle est bien en place.
- Attention ! Ne jamais dévisser la buse mélangeuse lorsque le système est sous pression. Actionner préalablement la touche de déverrouillage sur le pistolet à injecter pour éviter des éclaboussures inopinées de mortier.
- Lorsque vous utilisez le tube prolongateur: la première décharge de la résine doit se faire à partir du mélangeur ( et non pas du tube prolongateur flexible).
- Utiliser exclusivement le type de mélangeur fourni avec le mortier. Ne modifier la buse mélangeuse en aucun cas.
- Ne jamais utiliser de cartouches souples endommagées ni de porte-cartouches endommagés/très encrassés.

### Mauvaise fixation/défaillance du chevillage à cause d'un nettoyage insuffisant du trou foré.

- Les mèches creuses Hilti TE-CD, TE-YD doivent être associées à un modèle d'aspirateur Hilti bien entretenu d'une capacité d'aspiration (débit volumétrique) conforme à la spécification du tableau des accessoires.
- Avant de procéder à l'injection, s'assurer que le trou foré est exempt de débris de perçage, poussières, eau, glace, huile, graisse ou autres contaminants.
- Soufflage du trou foré – souffler avec de l'air comprimé exempt d'huile, jusqu'à ce que l'air sortant soit exempt de toute poussière.
- Brossage du trou foré – uniquement avec un écouvillon en acier adapté. Une résistance doit se faire sentir lors de l'insertion de l'écouvillon dans le trou
- Rinçage du trou foré – rincer le trou à l'eau à pression de conduite normale jusqu'à ce que de l'eau propre ressorte.
- Important ! Avant de remplir de mortier, évacuer l'eau du trou foré et le souffler avec de l'air comprimé exempt d'huile jusqu'à ce qu'il soit entièrement sec (Ne convient pas au trous forés au perforateur à percussion lors d'applications subaquatiques).

### Veiller à ce que le remplissage se fasse à partir du fond du trou foré pour éviter la formation de bulles d'air.

- Si nécessaire, utiliser des prolongateurs pour atteindre le fond du trou.
- En cas d'applications au plafond, utiliser l'accessoire HIT-SZ/IP et faire particulièrement attention lors de l'introduction de l'élément de fixation. L'excédent de mortier peut ressortir du trou foré. Veiller alors à ce que celui-ci ne goutte pas sur l'opérateur.
- Si une nouvelle buse mélangeuse est utilisée avec une cartouche déjà entamée, jeter également les premières pressions de mortier extrudé.
- Utiliser une nouvelle buse mélangeuse pour chaque cartouche souple neuve.

### Le non-respect des instructions peut entraîner une défaillance du chevillage!

## Resina ad iniezione per fissaggi con tondini per cemento armato e con tasselli nel calcestruzzo

► Prima dell'utilizzo, leggere le presenti Istruzioni per l'uso ed attenersi alle norme di sicurezza.

### Hilti HIT-RE 100

**Contiene:** prodotto di reazione: 2,2-bis-[4-(2,3-epossipropossi)fenil]-propano (A); Formaldehyde, oligomeric reaction products with 1-chloro-2,3-epoxypropane and phenol (A); Trimethylolpropane triglycidylether (A); 1,3-benzendimetanamina (B);



(A,B)



(A,B)



(A)



(A)



### Pericolo

- H314 Provoca gravi ustioni cutanee e gravi lesioni oculari.(A,B)  
H317 Può provocare una reazione allergica cutanea.(A,B)  
H341 Sospettato di provocare alterazioni genetiche. (A)  
H360 Può nuocere alla fertilità o al feto (A)  
H411 Tossico per gli organismi acquatici con effetti di lunga durata.(A,B)

- P280 Indossare guanti/indumenti protettivi/Proteggere gli occhi/il viso.  
P262 Evitare il contatto con gli occhi, la pelle o gli indumenti.

- P302+P352 IN CASO DI CONTATTO CON LA PELLE: lavare abbondantemente con acqua e sapone.  
P305+P351+P338 IN CASO DI CONTATTO CON GLI OCCHI: sciacquare accuratamente per parecchi minuti. Togliere le eventuali lenti a contatto se è agevole farlo. Continuare a sciacquare.  
P333+P313 In caso di irritazione o eruzione della pelle: consultare un medico.  
P337+P313 Se l'irritazione degli occhi persiste, consultare un medico.

### Rekomenduojamos asmeninės apsaugos priemonės

**Akių apsauga:** Tampriai prisispaudžiantys apsauginiai akiniai, pvz., #02065449 Apsauginiai akiniai PP EY-CA NCH, bespalviai; #2065591 Apsauginiai akiniai PP EY-HA R HC/AF, bespalviai;

**Rankų apsauga:** EN 374 / EN 388; Nuo tiesioginio kontakto su šia chemine medžiaga / produktu / mišiniu apsaugoti organizacinėmis priemonėmis.

**Už galutinį tinkamų asmeninės apsaugos priemonių pasirinkimą atsako vartotojas.**

### Avvertenze per lo smaltimento

#### Confezioni vuote

► codice rifiuto EAK: 15 01 02 imballaggi in plastica.

#### Confezioni piene/parzialmente vuote

- Procedere allo smaltimento in conformità alle normative ufficiali, come rifiuto speciale.
- Codice rifiuto EAK: 20 01 27\* colori, inchiostri da stampa, adesivi e resine sintetiche, contenenti sostanze pericolose.
  - oppure codice rifiuto EAK: 08 04 09\* residui di sostanze adesive e mastici, contenenti solventi di natura organica o altre sostanze pericolose.

**Contenuto:** 330 ml / 11.1 fl. oz      500 ml / 16.9 fl. oz

**Peso:** 475g / 16.7 oz      723g / 25.5 oz

Hilti non si assume alcuna responsabilità per eventuali danni causati da:

- condizioni di magazzino e trasporto diverse da quanto riportato nelle specifiche
- mancata osservanza delle Istruzioni per l'uso e dei dati di messa in opera, utilizzo erraneo
- tasselli non adeguatamente dimensionati, capacità di carico della base insufficiente
- altri effetti, non noti oppure non accettabili per Hilti, come ad esempio l'utilizzo di prodotti di terzi.

### Informazioni relative al prodotto

- Conservare le presenti Istruzioni per l'uso sempre unitamente al prodotto.
- Se affidato a terzi, il prodotto dev'essere sempre provvisto delle relative Istruzioni per l'uso.
- Scheda tecnica dati di sicurezza: prima di procedere con la lavorazione osservare le indicazioni riportate nella scheda tecnica dati di sicurezza.
- Data di scadenza: controllare la data di scadenza (mese/anno) riportata sulla giunzione della confezione. Una volta trascorsa la data di scadenza, il prodotto non deve più essere utilizzato.
- Temperatura della confezione durante l'utilizzo: da +5 °C a 40 °C / da 41 °F a 104 °F
- Condizioni di trasporto e magazzino: conservare in luogo fresco, asciutto e buio, ad una temperatura compresa tra +5 °C e 25 °C / tra 41 °F e 77 °F.
- In caso di applicazioni che non sono descritte nelle presenti Istruzioni per l'uso o che esulino dalle specifiche previste, rivolgersi a Hilti.
- Le cartucce parzialmente utilizzate devono rimanere nel portacartucce ed essere riutilizzate entro quattro settimane. Lasciare avvitato il miscelatore ed immagazzinare la cartuccia secondo le prescrizioni. In caso di riutilizzo, avvitare un nuovo miscelatore e scartare la prima resina pompata.

### **A** AVVERTENZA



#### **A** In caso di utilizzo non conforme, è possibile che la resina venga spruzzata fuori. Il contatto della resina con gli occhi può causare danni permanenti.

- Durante l'utilizzo del prodotto indossare appositi occhiali protettivi aderenti, guanti protettivi ed abbigliamento da lavoro!
- Non iniziare mai a pompare il prodotto se il miscelatore non è avvitato!
- Prima di utilizzare una nuova cartuccia avvitare un nuovo miscelatore. Accertarsi che il miscelatore sia inserito saldamente.
- Prudenza! Non svitare mai il miscelatore quando il sistema è sotto pressione. Prima premere il tasto di sbloccaggio sull'attrezzo, per evitare spruzzi di resina.
- Utilizzando un tubo flessibile di prolunga: lo scarto della prima resina pompata deve essere effettuato solo tramite il miscelatore in dotazione (non tramite il tubo flessibile di prolunga).
- Utilizzare esclusivamente il tipo di miscelatore fornito con la resina. Non modificare in alcun caso il miscelatore.
- Non utilizzare mai cartucce danneggiate e/o caricatori danneggiati o imbrattati.

#### **A** Valori di tenuta negativi/cedimento del fissaggio a causa di un'insufficiente pulizia del foro.

- Le punte per perforatori Hilti TE-CD, TE-YD devono essere utilizzate in combinazione con un aspiratore Hilti correttamente mantenuto, con modello e capacità di aspirazione (portata volumetrica) come specificato nella tabella degli accessori
- Prima di iniettare il prodotto, i fori devono essere asciutti e liberi da residui di foratura, polvere, acqua, ghiaccio, olio, grasso o altre impurità.
- Soffiaggio del foro – soffiare il foro con aria senza olio, finché l'aria che fuoriesce non risulti priva di polvere.
- Pulizia con scovolino - solo con adeguato scovolino metallico. Durante la pulizia, si deve avvertire una minima resistenza dello scovolino sulle pareti del foro; in caso contrario, lo scovolino è troppo piccolo e va sostituito.
- Lavaggio del foro – lavare con un tubo flessibile per l'acqua con pressione normale, finché l'acqua che fuoriesce non risulti pulita.
- Importante! Prima di iniettare la resina, rimuovere l'acqua dal foro e soffiare con aria compressa priva di olio, finché il foro non risulti completamente asciutto (non applicabile su un foro eseguito con martello pneumatico in applicazioni sott'acqua).

#### **A** Accertarsi che il riempimento del foro avvenga partendo dal fondo del foro stesso, affinché non vengano a crearsi bolle d'aria.

- Se necessario, utilizzare a tale scopo le apposite prolunghie per poter raggiungere il fondo del foro.
- In caso di applicazioni sopra testa, utilizzare l'accessorio HIT-SZ/IP e adattarlo soprattutto durante l'introduzione dell'elemento di fissaggio. È possibile che la resina in eccesso fuoriesca dal foro. Accertarsi che la resina non coli sull'utilizzatore.
- Se viene avvitato un nuovo miscelatore su una cartuccia già aperta, le prime pompage devono essere scartate.
- Per ogni nuova cartuccia utilizzare un nuovo miscelatore.

#### **A** La mancata osservanza delle Istruzioni d'uso può comportare il cedimento dell'ancoraggio!

## Resina de inyección para la fijación de anclajes y tacos en hormigón

► Lea estas instrucciones de uso y observe las indicaciones de seguridad antes de utilizar el producto.

### Hilti HIT-RE 100

**Contiene:** producto de reacción: 2,2-B;js(4-hidroxifenil)propano bis(2,3- epoxipropil) éter (A); Formaldehyde, oligomeric reaction products with 1-chloro-2,3-epoxypropane and phenol (A); Trimethylolpropane triglycidylether (A); 1,3-Bencenodi-metanamina (B);



(A,B)



(A,B)



(A)



(A)



### Peligro

- H314 Provoca quemaduras graves en la piel y lesiones oculares graves.(A,B)
- H317 Puede provocar una reacción alérgica en la piel.(A,B)
- H341 Se sospecha que provoca defectos genéticos. (A)
- H360 Puede perjudicar la fertilidad o dañar al feto (A)
- H411 Tóxico para los organismos acuáticos, con efectos nocivos duraderos.(A,B)

P280 Llevar guantes/prendas/gafas/máscara de protección.

P262 Evitar el contacto con los ojos, la piel o la ropa.

P302+P352 EN CASO DE CONTACTO CON LA PIEL: Lavar con agua y jabón abundantes

P305+P351+P338 EN CASO DE CONTACTO CON LOS OJOS: Aclarar cuidadosamente con agua durante varios minutos. Quitar las lentes de contacto, si lleva y resulta fácil. Seguir aclarando.

P333+P313 En caso de irritación o erupción cutánea: Consultar a un médico.

P337+P313 Si persiste la irritación ocular: Consultar a un médico.

### Equipo de protección recomendado:

**Protección de ojos:** gafas de protección herméticas p. ej. gafas de seguridad PP EY-CA NCH claras, código #02065449; gafas protectoras PP EY-HA R HC/AF claras, código #02065591.

**Protección de manos:** EN 374/EN388; material de los guantes: caucho nitrílico (NBR). Tome las medidas oportunas para evitar el contacto directo con la sustancia química/el producto/el preparado.

**El usuario es el responsable final de la elección de un equipo de protección apropiado.**

### Indicaciones de reciclaje

#### Cartuchos vacíos:

► el código de residuo LER: 15 01 02 embalajes de plastic.

#### Cartuchos llenos o parcialmente vacíos:

► Deberán eliminarse como residuos especiales de acuerdo con las normativas oficiales.

– Código de residuo LER: 20 01 27\* Pinturas, tintas, adhesivos y resinas que contienen sustancias peligrosas.

– o el código de residuo LER: 08 04 09\* Residuos de adhesivos y sellantes que contienen disolventes orgánicos u otras sustancias peligrosas.

**Contenido:** 330 ml / 11.1 fl. oz

500 ml / 16.9 fl. oz

**Peso:** 475g / 16.7 oz

723g / 25.5 oz



Hilti no acepta responsabilidad alguna por daños causados por:

- condiciones de almacenamiento y transporte diferentes a las especificadas
- incumplimiento de las instrucciones de uso y los datos de fijación, o utilización incorrecta
- anclajes mal dimensionados, capacidad de carga insuficiente de la superficie
- otros factores desconocidos o no atribuibles a Hilti como, por ejemplo, el uso de productos de otros fabricantes.

## Información de producto

- Guarde siempre estas instrucciones de uso junto con el producto.
- En caso de entregar el producto a terceros, deben incluirse siempre las instrucciones de uso.
- Hoja de datos de seguridad: consulte la hoja de datos de seguridad antes de utilizar el producto.
- Fecha de caducidad: compruebe la fecha de caducidad (mes/año) de la pieza de conexión del cartucho. El producto no debe utilizarse después de la fecha de caducidad.
- Temperatura del cartucho durante la utilización: de +5 °C a 40 °C / de 41 °F a 104 °F.
- Condiciones de transporte y almacenamiento: lugar fresco, seco y oscuro con una temperatura de +5 °C a 25 °C / de 41 °F a 77 °F.
- Para aplicaciones que no se describen en las presentes instrucciones de uso o no se enmarcan en la especificación, póngase en contacto con Hilti.
- Los cartuchos que no estén completamente vacíos deberán permanecer en el portacartuchos y utilizarse antes de cuatro semanas. Para ello deberán guardarse con el mezclador enroscado en las condiciones de almacenamiento recomendadas. Antes de utilizarlo de nuevo, enroscar un nuevo mezclador y desechar la resina inicial.

### **A** ADVERTENCIA



#### **A** La resina puede salpicar si se utiliza incorrectamente. El contacto de la resina con los ojos puede causar daños oculares permanentes.

- Lleve gafas protectoras herméticas, guantes de protección y ropa de trabajo durante el trabajo.
- No comience a exprimir si no se ha enroscado el mezclador.
- Enrosque un mezclador nuevo antes de exprimir un cartucho nuevo. Asegúrese de que el asiento sea firme.
- ¡Precaución! No desatornille nunca el mezclador cuando el sistema se encuentre bajo presión. Presione de antemano la tecla de desbloqueo en el aparato para evitar que siga saliendo resina.
- Cuando utilice la manguera de extensión: El descarte inicial de la resina se debe hacer a través del mezclador suministrado ( y no a través de la manguera de extensión).
- Utilice exclusivamente el modelo de mezclador suministrado con la resina. No modifique el mezclador en ningún caso.
- No utilice cartuchos en mal estado ni portacartuchos dañados o sucios.

#### **A** Valores de sujeción deficientes/fallo de la fijación debido a limpieza insuficiente del taladro.

- Las brocas huecas TE-CD, TE-YD de Hilti deben utilizarse con una aspiradora de Hilti del modelo y la capacidad de succión (tasa de flujo volumétrico) que se especifican en la tabla de accesorios
- Antes de inyectar la resina, los taladros deben estar secos y libres de restos de perforación, polvo, agua, hielo, aceite, grasa o cualquier otro agente contaminante.
- Soplado a presión del taladro: limpie el taladro con aire a presión sin aceite hasta que el aire de retorno esté libre de polvo.
- Limpieza del taladro: realícese sólo con un cepillo metálico de tamaño apropiado. Al cepillar el taladro, se notará cierta resistencia en el cepillo
- Lavado del taladro: lave con una manguera de agua con la presión normal de la red hasta que salga agua limpia.
- ¡Atención! Antes de añadir la resina es necesario extraer el agua del taladro y limpiar el taladro con aire a presión sin aceite hasta que quede completamente seco (no aplica para agujeros realizados con taladros de percusión en aplicaciones sumergidas en agua).

#### **A** Verificar que el relleno del taladro se produce desde el fondo del taladro para que no se formen burbujas de aire.

- Si es necesario, utilice las prolongaciones para alcanzar el fondo del taladro.
- En aplicaciones por encima de la cabeza, utilice el accesorio HIT-SZ/IP y preste especial atención al introducir el elemento de fijación. Puede salir resina sobrante del taladro. Asegúrese de que la resina no gotee sobre el usuario.
- Si se enrosca un nuevo mezclador en un cartucho ya abierto, las primeras aplicaciones deben también desecharse.
- Utilice un nuevo mezclador para cada cartucho nuevo.

#### **A** El incumplimiento de estas instrucciones puede llevar a una fijación incorrecta.

## Buchas químicas para fixações de ferros e de ancoragens em betão

► Antes da utilização, ler este manual de instruções e respeitar a ficha de segurança.

### Hiti HIT-RE 100

**Contém:** produto de reacção: 2,2-Bis(4-hidroxifenil)propano bis(2,3-epoxipropil) éter (A); Formaldehyde, oligomeric reaction products with 1-chloro-2,3-epoxypropane and phenol (A); Trimethylolpropane triglycidylether (A); 1,3-Benzenodimetamina (B);



(A,B)



(A,B)



(A)



(A)



### Perigo

- |      |                                                                  |
|------|------------------------------------------------------------------|
| H314 | Provoca queimaduras na pele e lesões oculares graves.(A,B)       |
| H317 | Pode provocar uma reacção alérgica cutânea.(A,B)                 |
| H341 | Suspeito de provocar anomalias genéticas. (A)                    |
| H360 | Pode afectar a fertilidade ou o nascituro (A)                    |
| H411 | Tóxico para os organismos aquáticos com efeitos duradouros.(A,B) |

P280 Usar luvas de protecção/vestuário de protecção/protecção ocular/protecção facial.

P262 Não pode entrar em contacto com os olhos, a pele ou a roupa.

P302+P352 SE ENTRAR EM CONTACTO COM A PELE: lavar com sabonete e água abundantes.

P305+P351+P338 SE ENTRAR EM CONTACTO COM OS OLHOS: enxaguar cuidadosamente com água durante vários minutos. Se usar lentes de contacto, retire-as, se tal lhe for possível. Continuar a enxaguar.

P333+P313 Em caso de irritação ou erupção cutânea: consulte um médico.

P337+P313 Caso a irritação ocular persista: consulte um médico.

### Equipamento de protecção recomendado:

**Protecção dos olhos:** óculos de protecção por ex.: #02065449 Óculos de segurança PP EY-CA NCH claro; #02065591 Goggles PP EY-HA R HC/AF claro;

**Protecção das mãos:** EN 374 / EN 388; Deve-se evitar o contacto directo com o químico / o produto / o preparado através de medidas organizadas.

**A escolha final dos equipamentos de protecção apropriados é da responsabilidade do utilizador**

### Nota sobre reciclagem

#### Cartuchos vazios

► Código CER: 150102 Embalagens de plastic.

#### Cartuchos semiusados/novos:

► Remover de acordo com as normas e regulamentações legais sobre resíduos especiais.

– Código CER: 20 01 27\* Tintas, produtos adesivos, colas e resinas, contendo substâncias perigosas.

– ou Código CER: 08 04 09\* Resíduos de colas ou vedantes, contendo solventes orgânicos ou outras substâncias perigosas.

**Conteúdo líquido:** 330 ml / 11.1 fl. oz    500 ml / 16.9 fl. oz

**Peso:** 475g / 16.7 oz    723g / 25.5 oz

A Hilti não assume responsabilidade por danos provocados por:

- condições de armazenagem/transporte contrárias às especificadas
- falha na observância das condições de utilização/colocação, aplicação incorrecta
- uso de buchas com dimensão inadequada, insuficiente capacidade de resistência à carga do material base
- como resultado de influências desconhecidas ou inaceitáveis para a Hilti, por exemplo, a utilização de produtos de outros fabricantes.

### Dados informativos sobre o produto

- Guarde estas instruções de utilização sempre em conjunto com o produto.
- Entregue o produto a outras pessoas apenas juntamente com as instruções de utilização.
- Ficha de segurança: antes de iniciar os trabalhos, tenha em consideração a ficha de segurança.
- Prazo de validade: veja o prazo de validade (mês/ano) na peça de junção do cartucho. Não utilize produtos cujo prazo de validade se encontre ultrapassado.
- Temperatura do cartucho durante a utilização: entre +5 °C e 40 °C / 41 °F e 104 °F.
- Condições de transporte e armazenagem: em lugar fresco, seco e ao abrigo da luz, entre +5 °C e 25 °C / 41 °F e 77 °F.
- Em caso de aplicações que não se encontrem descritas nas presentes instruções de utilização ou estejam fora das especificações, é favor dirigir-se à Hilti.
- As sobras de cartuchos parcialmente usados devem permanecer no suporte e ser utilizadas num prazo de quatro semanas. Deixe o misturador enroscado e armazene-o juntamente com o cartucho, de acordo com as condições de armazenagem preconizadas. Quando/se reutilizados, utilize um misturador novo e não utilize novamente a resina inicial.

pt

### ATENÇÃO



#### **⚠ No caso de manuseamento incorrecto, é possível que seja injectada resina. O contacto da resina com os olhos pode provocar lesões oculares permanentes!**

- Durante a realização de trabalhos, use óculos de protecção que fiquem bem justos, luvas de protecção e roupa de trabalho!
- Nunca comece a aplicação sem que o misturador esteja enroscado!
- Antes da aplicação de um novo cartucho, enrosque um misturador novo. Certifique-se de que está bem apertado.
- Cuidado! Nunca desenrosque o misturador quando o sistema está sob pressão. Pressione previamente a alavanca de libertação na ferramenta para evitar projecções de resina.
- Quando utilizar a mangueira de extensão: O descarte inicial de resina deve ser feito através do misturador fornecido (e não através da mangueira de extensão).
- Utilize apenas o tipo de misturador fornecido com a resina. Não modifique o misturador de forma alguma.
- Nunca utilize cartuchos danificados e/ou suportes danificados ou sujos.

#### **⚠ Valores de retenção deficientes/falha da fixação devido a limpeza insuficiente do furo.**

- A brocas de perfuração ocas Hilti TE-CD e TE-YD têm de ser usadas em conjunto com um aspirador Hilti em boas condições de funcionamento e com o modelo e capacidade de aspiração (débito volumétrico) especificados na tabela dos acessórios
- Os furos devem estar secos e livres de material de perfuração, pó, água, gelo, óleo, gordura ou outras impurezas antes de efectuar a injeção.
- Limpar o furo por sopro – limpe o furo por sopro com ar isento de óleo, até que o ar saia sem pó.
- Escovar o furo – apenas com uma escova de aço adequada. Ao escovar o furo deverá ser perceptível uma resistência na escova
- Lavar o furo – lave com uma mangueira com pressão normal, até sair água limpa.
- Importante! Antes de preencher com resina, retire a água do furo e sopre com ar isento de óleo até estar totalmente seco (Não utilizável em furos subaquáticos executados com percussão).

#### **⚠ Certifique-se de que o enchimento do furo é efectuado a partir do fundo, para que não se formem bolhas de ar.**

- Se necessário, utilize os prolongadores para alcançar o fundo do furo.
- No caso de aplicações em suspensão, utilize o acessório HIT-SZ/JP e preste especial atenção ao inserir o elemento de fixação. Pode sair resina em excesso do furo. Certifique-se de que não pinga resina sobre o utilizador.
- Se for enroscado um misturador novo num cartucho já aberto, também não utilize o produto das primeiras bombadas.
- Para cada cartucho novo deverá utilizar-se um misturador novo.

#### **⚠ A não observação das instruções pode conduzir à falha da fixação!**

## Ankermortel voor bevestiging van betonijzer en pluggen in beton

► Voor gebruik deze gebruiksaanwijzing lezen en de veiligheidsvoorschriften aanhouden.

### Hiiti HIT-RE 100

**Bevat:** 2,2-bis(4-hydroxyfenyl)propan-bis(2,3-epoxypropyl)ether (A); Formaldehyde, oligomeric reaction products with 1-chloro-2,3-epoxypropane and phenol (A); Trimethylolpropane triglycidylether (A); m-Xyleen,  $\alpha,\alpha'$ -diamine (B);



(A,B)



(A,B)



(A)



(A)



### Gevaar

H314	Veroorzaakt ernstige brandwonden en oogletsel.(A,B)
H317	Kan een allergische huidreactie veroorzaken.(A,B)
H341	Verdacht van het veroorzaken van genetische schade. (A)
H360	Kan de vruchtbaarheid of het ongeboren kind schaden (A)
H411	Giftig voor in het water levende organismen, met langdurige gevolgen.(A,B)
P280	Beschermende handschoenen/beschermende kleding/oogbescherming/gelaatsbescherming dragen.
P262	Contact met de ogen, de huid of de kleding vermijden.
P302+P352	BIJ CONTACT MET DE HUID: met veel water en zeep wassen.
P305+P351+P338	BIJ CONTACT MET DE OGEN: voorzichtig afspoelen met water gedurende een aantal minuten; contactlenzen verwijderen, indien mogelijk; blijven spoelen.
P333+P313	Bij huidirritatie of uitslag: een arts raadplegen.
P337+P313	Bij aanhoudende oogirritatie: een arts raadplegen.

### Aanbevolgen veiligheidsuitrusting

**Oogbescherming:** Nauw aansluitende schutbril bijv.: #02065449 Veiligheidsbril PP EY-CA NCH klaar; #02065591 Beschermbril PP EY-HA R HC/AF klaar

**Handbescherming:** EN 374 / EN 388; Rechtstreeks contact met chemicaliën / product / de bereiding moet door organisatorische maatregelen worden vermeden.

**De definitieve selectie van geschikte kleding is in de verantwoordelijkheid van de gebruiker**

### Aanwijzingen voor afvalverwerking

#### Geleegde patronen

► EAK-afvalcode: 15 01 02 kunststof verpakkingen.

#### Volle/gedeeltelijk geleegde patronen:

- Met inachtneming van de officiële voorschriften als speciaal afval afvoeren.
  - EAK-afvalcode: 20 01 27\* lakken, drukinkt, lijmen en kunstharsen, die gevaarlijke stoffen bevatten.
  - of EAK-afvalcode: 08 04 09\* lijm- en kitafval, dat organische oplosmiddelen of andere gevaarlijke stoffen bevat.

**Inhoud:** 330 ml / 11.1 fl. oz      500 ml / 16.9 fl. oz

**Gewicht:** 475g / 16.7 oz      723g / 25.5 oz

Hilti kan niet aansprakelijk worden gesteld voor schade veroorzaakt door:

- Opslag- en transportomstandigheden die afwijken van de voorschriften
- Het niet naleven van de handleiding en de indrijfgegevens, verkeerd gebruik
- Het niet toereikend bemeten van de verankering, ontoereikend draagvermogen van de ondergrond
- Andere invloeden die Hilti niet bekend zijn of waarvoor Hilti niet aansprakelijk is, zoals het gebruik van producten van derden.

## Productinformatie

- Bewaar deze handleiding altijd bij het product.
- Geef het product alleen samen met de handleiding aan andere personen door.
- Veiligheidskaart: Voor aanvang van de werkzaamheden de veiligheidskaart lezen.
- Houdbaarheidsdatum: De houdbaarheidsdatum (maand/jaar) op het verbindingsdeel van de patroon controleren. Het product mag na afloop niet meer worden gebruikt.
- Temperatuur van de patroon tijdens het gebruik: +5 °C tot 40 °C / 41 °F tot 104 °F.
- Transport- en opslagcondities: Koel, droog en donker bij +5 °C tot 25 °C / 41 °F tot 77 °F.
- Voor toepassingen die niet in deze handleiding zijn beschreven of die buiten de specificaties liggen, contact opnemen met Hilti.
- Niet volledig opgebruikte foliepatronen moeten in de cassette blijven en binnen vier weken worden gebruikt. De mengtuit opgeschroefd laten en de patroon volgens voorschrift opslaan. Bij verder gebruik een nieuwe mengtuit opschroeven en de voorlooppompe afvoeren.

nl

## WAARSCHUWING



### **⚠ Ondeskundig gebruik kan mortelspatten veroorzaken. Oogcontact met de mortel kan blijvend oogletsel veroorzaken!**

- Tijdens het werk een goed sluitende veiligheidsbril, werkhandschoenen en werkkleding dragen!
- Nooit zonder aangebrachte mengtuit met het uitpersen van de mortel beginnen!
- Bij gebruik van een nieuwe foliepatroon een nieuwe mengtuit aanbrengen. Op een correcte montage letten.
- Attentie! Nooit de mengtuit verwijderen als het systeem onder druk staat. Eerst de ontgrendelingstoets op het apparaat indrukken om mortelspatten te voorkomen.
- Bij gebruik van een nieuwe foliepatroon een nieuwe mengtuit aanbrengen. Op een correcte montage letten.
- Uitsluitend de met de mortel geleverde mengtuit gebruiken. De mengtuit onder geen enkele omstandigheid veranderen.
- Nooit beschadigde foliepatronen en/of beschadigde of sterk vervuilde patroonhouders gebruiken.

### **⚠ Slechte bevestigingswaarden/falen van de bevestiging door ontoereikende reiniging van het boorgat.**

- Hilti TE-CD en TE-YD holle boren moeten worden gebruikt met een goed onderhouden Hilti-stofzuiger van het model en met het zuigvermogen (debiet) zoals omschreven in de accessoiretabel
- Voor het injecteren moeten de boorgaten droog en vrij zijn van boorafval, stof, water, ijs, olie, vet of andere verontreinigingen.
- Uitblazen van het boorgat – het boorgat met olievrije lucht uitblazen, tot de terugstromende lucht stofvrij is.
- Uitborstelen van het boorgat – alleen met een passende staalborstel. Bij het uitborstelen van het boorgat moet aan de borstel een lichte weerstand voelbaar te zijn
- Uitspoelen van het boorgat – met een waterslang en normale leidingdruk uitspoelen tot er helder water uitstroomt.
- **BELANGRIJK!** Vóór het vullen met mortel het water uit het boorgat verwijderen en het gat met olievrije perslucht uitblazen tot het volledig droog is (niet van toepassing bij hamergeboorde gaten bij onderwatertoepassingen).

### **⚠ Opletten dat het vullen van het boorgat vanaf het einde van het boorgat plaatsvindt, zodat er geen luchtballen ontstaan.**

- Indien noodzakelijk de verlengstukken gebruiken om het einde van het boorgat te bereiken.
- Bij gebruik boven het hoofd het accessoire HIT-SZ/IP gebruiken en met name oppassen bij het invoeren van het bevestigingselement. Overtollige mortel kan uit het boorgat stromen. Opletten dat er geen mortel op de gebruiker druppelt.
- Indien een nieuwe mengtuit op een reeds geopend foliepatroon wordt geschroefd, de eerste slagen eveneens weggooien.
- Voor iedere nieuwe foliepatroon een nieuwe mengtuit gebruiken.

### **⚠ Als deze aanwijzingen niet worden opgevolgd kan de bevestiging loskomen!**

## Χημικό αγκύριο για στερεώσεις αναμονών οπλισμού και κοχλιών αγκύρωσης σε σκυρόδεμα

► Πριν από τη χρήση, διαβάστε αυτές τις οδηγίες χρήσης και ακολουθήστε τις προδιαγραφές ασφαλείας.

### HiHi HIT-RE 100

**Περιέχει:** προϊόν αντιδράσεως: δις[4-(2,3-εποξυπροποξυ)φαινυλο]προπάνιο (A); Formaldehyde, oligomeric reaction products with 1-chloro-2,3-epoxypropane and phenol (A); Trimethylolpropane triglycidylether (A); 1,3-Βενζολοδιμεθαναμίνη (B);



(A,B)



(A,B)



(A)



(A)



### Κίνδυνος

H314 Προκαλεί σοβαρά δερματικά εγκαύματα και οφθαλμικές βλάβες. (A,B)

H317 Μπορεί να προκαλέσει αλλεργική δερματική αντίδραση.(A,B)

H341 Υποπτο για πρόκληση γενετικών ελαττωμάτων. (A)

H360 Μπορεί να βλάψει τη γονιμότητα ή το έμβρυο (A)

H411 Τοξικό για τους υδρόβιους οργανισμούς, με μακροχρόνιες επιπτώσεις.(A,B)

P280 Να φοράτε προστατευτικά γάντια/προστατευτικά ενδύματα/μέσα ατομικής προστασίας για τα μάτια/πρόσωπο.

P262 Να μην έρθει σε επαφή με τα μάτια, με το δέρμα ή με τα ρούχα.

P302+P352 ΣΕ ΠΕΡΙΠΤΩΣΗ ΕΠΑΦΗΣ ΜΕ ΤΟ ΔΕΡΜΑ: Πλύνετε με άφθονο νερό και σαπούνι.

P305+P351+P338 ΣΕ ΠΕΡΙΠΤΩΣΗ ΕΠΑΦΗΣ ΜΕ ΤΑ ΜΑΤΙΑ: Ξεπλύνετε προσεκτικά με νερό για αρκετά λεπτά.

Εάν υπάρχουν φακοί επαφής, αφαιρέστε τους, εφόσον είναι εύκολο. Συνεχίστε να ξεπλένετε.

P333+P313 Εάν παρατηρηθεί ερεθισμός του δέρματος ή εμφανιστεί εξάνθημα: Συμβουλευθείτε/Επισκεφθείτε γιατρό.

P337+P313 Εάν δεν υποχωρεί ο οφθαλμικός ερεθισμός: Συμβουλευθείτε/Επισκεφθείτε γιατρό.

### Προτεινόμενα μέσα ατομικής προστασίας

**Προστασία για τα μάτια:** Προστατευτικά γυαλιά απολύτως εφαρμοστά. π.χ.: #02065449 Γυαλιά ασφαλείας PP EY-CA NCH διαφανή, #02065591 Προστατευτικά γυαλιά PP EY-HA R HC/AF διαφανή.

**Προστασία για τα χέρια:** EN 374 / EN 388; Θα πρέπει να ληφθούν μέτρα ώστε να αποφευχθεί η άμεση επαφή με τη χημική ουσία / το προϊόν /

**Η τελική επιλογή του κατάλληλου μέσου ατομικής προστασίας εναπόκειται στην ευθύνη του χρήστη**

### Υποδείξεις για τη διάθεση στα απορρίμματα

#### Άδειες αμπούλες

► κωδικός απορριμμάτων EAK: 15 01 02 Συσκευασίες από πλαστικό.

#### Γεμάτες/μισογεμάτες αμπούλες:

► Διάθεση ως ειδικά απορρίμματα λαμβάνοντας υπόψη τις σχετικές διατάξεις.

- Κωδικός απορριμμάτων EAK: 20 01 27\* Χρώματα, μελάνια, κόλλες και συνθετικές ρητίνες, που περιέχουν επικίνδυνες ουσίες.
- ή κωδικός απορριμμάτων EAK: 08 04 09\* Απορρίμματα κολλητικών και στεγανοποιητικών υλικών, που περιέχουν οργανικά διαλυτικά ή άλλες επικίνδυνες ουσίες.

**Περιεχόμενο:** 330 ml / 11.1 fl. oz

500 ml / 16.9 fl. oz

**Βάρος:** 475g / 16.7 oz

723g / 25.5 oz

Η Hilti δεν αναλαμβάνει καμία ευθύνη για ζημιές που προέρχονται από:

- συνθήκες αποθήκευσης και μεταφοράς που αποκλίνουν από τις προδιαγραφές
- παραβλέψη των οδηγιών χρήσης και των στοιχείων τοποθέτησης, λανθασμένη εφαρμογή
- ανεπαρκή διαστασιολόγηση της αγκύρωσης, ανεπαρκή αντοχή του υποστρώματος
- άλλες επιδόσεις, που δεν είναι γνωστές στη Hilti ή για τις οποίες δεν ευθύνεται η Hilti, όπως π.χ. η χρήση προϊόντων τρίτων κατασκευαστών.

#### Πληροφορίες προϊόντος

- Φυλάσσετε τις παρούσες οδηγίες χρήσης πάντα μαζί με το προϊόν.
- Δίνετε το προϊόν σε άλλους μόνο μαζί με τις οδηγίες χρήσης.
- Φύλλο δεδομένων ασφαλείας: Συμβουλευτείτε το φύλλο δεδομένων ασφαλείας πριν από την εργασία.
- Ημερομηνία λήξης: Ελέγξτε την ημερομηνία λήξης (μήνας/έτος) στο τμήμα σύνδεσης της αμπούλας. Δεν επιτρέπεται η χρήση του προϊόντος μετά την ημερομηνία λήξης.
- Θερμοκρασία αμπούλας κατά τη χρήση: +5 °C έως 40 °C / 41 °F έως 104 °F.
- Συνθήκες μεταφοράς και αποθήκευσης: Σε δροσερό, στεγνό και σκοτεινό χώρο από +5 °C έως 25 °C / 41 °F έως 77 °F.
- Παρακαλούμε απευθυνθείτε στη Hilti για εφαρμογές, που δεν περιγράφονται στις παρούσες οδηγίες χρήσης ή βρίσκονται εκτός προδιαγραφών.
- Οι αμπούλες που δεν έχουν καταναλωθεί πρέπει να χρησιμοποιηθούν ξανά εντός τεσσάρων εβδομάδων. Αφήστε βιδωμένο τον αναμικτή και αποθηκεύστε την αμπούλα σύμφωνα με τις προδιαγραφές. Όταν την χρησιμοποιήσετε ξανά, βιδώστε καινούργιο αναμικτή και πετάξτε το πρώτο υλικό που θα εξέλθει.

#### **⚠ ΠΡΟΕΙΔΟΠΟΙΗΣΗ**



#### **⚠ Σε περίπτωση ακατάλληλης χρήσης υπάρχει το ενδεχόμενο πιπιλισματος του υλικού. Η επαφή του υλικού με τα μάτια ενδέχεται να προκαλέσει μόνιμες οφθαλμικές βλάβες!**

- Φοράτε κατά την εργασία εφαρμοστά γυαλιά προστασίας, προστατευτικά γάντια και φόρμα εργασίας!
- Ποτέ μην αρχίζετε την εφαρμογή χωρίς βιδωμένο τον αναμικτή!
- Πριν από τη χρήση μιας καινούργιας αμπούλας, βιδώστε καινούργιο αναμικτή. Βεβαιωθείτε ότι εδράζει καλά.
- Προσοχή! Ποτέ μην ξεβιδώνετε τον αναμικτή, όταν το σύστημα βρίσκεται υπό πίεση. Πατήστε προηγουμένως το πλήκτρο απασφάλισης στο εργαλείο, για την αποφυγή πιπιλισμάτων του υλικού.
- Σε περίπτωση χρήσης εύκαμπτου σωλήνα προέκτασης: πετάξτε το πρώτο κόνιαμα μόνο μέσω του αναμικτή που παραλάβατε (όχι μέσω του εύκαμπτου σωλήνα προέκτασης).
- Χρησιμοποιείτε αποκλειστικά και μόνο τον τύπο αναμικτή που παραλάβατε μαζί με το χημικό αγκύριο. Σε καμία περίπτωση μην κάνετε τροποποιήσεις στον αναμικτή.
- Ποτέ μην χρησιμοποιείτε αμπούλες και/ή κασέτες που έχουν υποστεί ζημιά ή είναι λερωμένες.

#### **⚠ Κακές τιμές συγκράτησης/αποτυχία της στερέωσης από ανεπαρκή καθαρισμό της οπής διάτρησης.**

- Τα ειδικά τρυπάνια Hilti TE-CD και TE-YD πρέπει να χρησιμοποιούνται σε συνδυασμό με σωστά συντηρημένη ηλεκτρική σκούπα Hilti, το μοντέλο και η απορροφητική ικανότητα (παροχή όγκου) της οποίας θα είναι σύμφωνη με όσα καθορίζονται στον πίνακα των αξεσουάρ
- Πριν από την έγχυση, πρέπει οι οπές διάτρησης να είναι στεγνές και απαλλαγμένες από υπολείμματα διάτρησης, σκόνη, νερό, πάγο, λάδι, βράσο ή άλλες ακαθαρσίες.
- Καθαρισμός οπής διάτρησης με ψύξημα – φυσήξτε την οπή διάτρησης με αέρα χωρίς λάδι, μέχρι ο αέρας που επιστρέφει να μην έχει σκόνη.
- Βούρτσισμα της οπής διάτρησης – μόνο με κατάλληλη ουρματόβουρτσα. Κατά το βούρτσισμα της οπής διάτρησης πρέπει να είναι αισθητή μια αντίσταση στη βούρτσα
- Εκκλιση της οπής διάτρησης – ξεπλύντε με λάστιχο νερού με κανονική πίεση δικτύου ύδρευσης μέχρι να εξέρχεται καθαρό νερό.
- Σημαντικό! Πριν από την πλήρωση με υλικό, απομακρύνετε το νερό από την οπή διάτρησης και φυσήξτε την με πεπιεσμένο αέρα χωρίς λάδι, μέχρι να στεγνωθεί τελείως (δεν αφορά οπή διανοιγμένη με κρουστικό δράσιον σε υπόγειες εφαρμογές).

#### **⚠ Βεβαιωθείτε ότι η πλήρωση της οπής διάτρησης πραγματοποιείται από τον πυθμένα της οπής, για να μη σχηματιστούν φυσαλίδες αέρα.**

- Εάν χρειάζεται, χρησιμοποιήστε για αυτό το σκοπό προεκτάσεις για να φτάσετε στον πυθμένα της οπής.
- Σε εφαρμογές πάνω από το κεφάλι σας, χρησιμοποιήστε το αξεσουάρ HIT-SZ/1P και προσέχετε ιδιαίτερα κατά την εισαγωγή του εξαρτήματος στερέωσης. Ενδέχεται να εξέλθει πλεονάζον υλικό από την οπή διάτρησης. Φροντίστε να μην σπάει υλικό πάνω σας.
- Εάν βιδώσετε καινούργιο αναμικτή σε ήδη ανοιχτή αμπούλα, πετάξτε επίσης τις πρώτες δόσεις.
- Για κάθε καινούργια αμπούλα χρησιμοποιείτε καινούργιο αναμικτή.

#### **⚠ Εάν παραβλέψετε τις οδηγίες μπορεί να αποτύχει η στερέωση!**

## Beton demiri ve dübellerin beton içerisinde sabitlenmesi için bağlantı harcı

► Kullanımdan önce, bu kullanım kılavuzunu okuyunuz ve güvenlik yönetmeliklerine uyunuz.

### HİTİ HIT-RE 100

**İçerdiği maddeler:** reaksiyon ürünü: 2,2'-[(1-metiletilidin)bis(4,1-fenilenokzimetenil)]bisokziran (A); Formaldehyde, oligomeric reaction products with 1-chloro-2,3-epoxypropane and phenol (A); Trimethylolpropane triglycidylether (A); m-Xylylenediamine (B);



(A,B)



(A,B)



(A)



(A)



### Tehlike

H314	Ciddi cilt yanıklarına ve göz hasarına yol açar. (A,B)
H317	Alerjik cilt reaksiyonlarına yol açar.(A,B)
H341	Genetik hasara yol açma şüphesi var. (A)
H360	Doğmamış çocukta hasara yol açabilir veya üremeye zarar verebilir (A)
H411	Sucul ortamda uzun süre kalıcı, toksik etki.(A,B)

P280	Koruyucu eldiven/koruyucu kıyafet/göz koruyucu/yüz koruyucu kullanın.
P262	Gözle, ciltle veya kıyafetle temas ettirmeyin.
P302+P352	DERİ İLE TEMAS HALİNDE İSE: Bol sabun ve su ile yıkayın.
P305+P351+P338	GÖZ İLE TEMASI HALİNDE: Su ile birkaç dakika dikkatlice durulayın. Takılı ve yapması kolaysa, kontak lensleri çıkartın. Durulamaya devam edin.
P333+P313	Ciltte tahriş veya kaşıntı söz konusu ise: Tıbbi yardım/müdahale alın.
P337+P313	Göz tahrişi kalıcı ise: Tıbbi yardım/bakım alın.

### Koruma donanımı önerisi

**Göz koruması:** Kenarları sıkı kapanan koruyucu gözlük örneğin: #02065449 koruyucu gözlük PP EY-CA NCH şeffaf; #02065591 koruyucu gözlük PP EY-HA R HC/AF şeffaf;

**El koruması:** EN 374 / EN 388; Eldiven malzemesi: Nitril kauçuk, NBR Kimyasal maddeler/ürünler/hazırlanmış malzeme ile doğrudan temas, organizasyon önlemleri almak sureti ile engellenmelidir.

**Uygun koruma donanımı için nihai seçim sorumluluğu kullanıcıya aittir.**

### İmha edilmesine dair uyarılar

#### Boşaltılmış bidonlar

► EAK atık kodu: 15 01 02 plastik ambalajlar.

#### Dolu/kısmen boşaltılmış bidonlar:

- Resmi makamların talimatları dikkate alınmak suretiyle özel çöp olarak imha edilmelidir.
- AAK-Atık kodu: 20 01 27\* tehlikeli maddeler içeren boyalar, baskı boyaaları, yapıştırıcı maddeler ve sentetik reçineler.
  - veya EAK atık kodu: 08 04 09\* Organik çözücüler veya diğer tehlikeli maddeleri içeren yapıştırıcı madde atıkları ve katı madde atıkları.

<b>Miktarı:</b>	330 ml / 11.1 fl. oz	500 ml / 16.9 fl. oz
<b>Ağırlık:</b>	475g / 16.7 oz	723g / 25.5 oz



Hilti aşağıdaki hasarlar için sorumluluk kabul etmez:

- talimatlardan farklı depolama ve nakliye şartlarından,
- kullanma talimatının ve kullanma sürelerinin dikkate alınmamasından, hatalı kullanımdan,
- yetersiz bağlantı ölçümünden, zeminin yetersiz yük taşıma kapasitesinden,
- Hilti'nin bilmediği veya Hilti'nin sorumlu olmadığı diğer etkenlerden dolayı, örn. başka üreticilere ait ürünlerin kullanılmasından oluşan hasarlardan dolayı sorumluluk üstlenmez.

## Ürün bilgisi

- Bu kullanma talimatını daima ürünle birlikte muhafaza ediniz.
- Ürünü, başka şahıslara ancak kullanma talimatıyla birlikte veriniz.
- Güvenlik Bilgileri Sayfası: Çalışmaya başlamadan önce Güvenlik Bilgileri Sayfası'nı dikkate alınız.
- Son kullanma tarihi: Bidonun bağlantı parçası üzerindeki son kullanma tarihini (Ay/Yıl) kontrol ediniz. Ürün, bu tarihten sonra artık kullanılamaz.
- Kullanma esasında bidonun sıcaklığı: +5 °C – 40 °C / 41 °F – 104 °F.
- Nakliye ve depolama şartları: Serin, kuru ve karanlık yerde +5 °C – 25 °C / 41 °F – 77 °F arasında muhafaza ediniz.
- Ürünü, elinizdeki bu kullanma talimatında anlatılmayan veya ürün niteliklerinin dışında kalan yerlerde uygulayacaksanız bu durumda lütfen Hilti'ye müracaat ediniz.
- Tamamen kullanılmamış folyo tüpler dört hafta içerisinde kullanılmak zorundadır. Karıştırıcıyı takılı vaziyette bırakınız ve bidonu talimatlara uygun şekilde depolayınız. Tekrar kullandığınızda yeni bir karıştırıcı takınız ve öndeki harcı boşaltınız.

tr

## ⚠ UYARI



### ⚠ Usulüne uygun kullanılmaması halinde harç fıskırabilir. Harcın gözle temas etmesi kalıcı göz hasarlarına neden olabilir!

- Çalışma esnasında gözünüzü sıkıca kapatan bir koruyucu gözlük, koruyucu eldiven takınız ve iş elbisesi giyiniz!
- Karıştırıcı taktıktan kesinlikle sıkmaya başlamayınız!
- Yeni bir folyo tüpü sıkmaya başlamadan önce yeni bir karıştırıcı takınız. Sabit durmasına dikkat ediniz.
- Dikkat! Sistem basınç altındayken kesinlikle karıştırıcıyı sökmeyiniz. Etrafa harç sıçramasını engellemek için önceden aletteki kilit açma tuşuna basınız.
- Uzatma hortumu kullanılması: Mevcut harcın tahliyesi yalnızca belirtilen karıştırıcı ile yapılmalıdır (uzatma hortumlarıyla değil)
- Sadece harç ile birlikte gönderilen karıştırıcı tipini kullanınız. Karıştırıcıyı hiçbir durumda değiştirmeyiniz.
- Kesinlikle hasarlı folyo tüp ve/veya hasarlı veya kirli kaset kullanılmamalıdır.

### ⚠ Deliklerin yeterince temizlenmesi tutma değerlerinin kötü olmasına/bağlantının tutmamasına yol açar.

- Hilti TE-CD, TE-YD tozsuz delme uçları, aksesuar tablosunda belirtilen model ve emme kapasitesindeki (hacimsel debi), bakımı uygun şekilde yapılan bir Hilti elektrik süpürgesiyle birlikte kullanılmalıdır.
- Enjektetmeden önce deliklerin kuru ve delme atıklarından, tozdan, sudan, buzdan, yağdan, gres yağından veya diğer kirlerden arındırılması gerekir.
- Deliğe hava tutma – Geri dönen havada toz kalmıyınca kadar deliğe içinde yağ bulunmayan hava tutunuz.
- Deliklerin fırçalanması – yalnızca uygun çelik fırçalar ile gerçekleştirilmelidir. Deliklerin fırçalanması sırasında, fırçada bir direncin hissedilmesi gerekir
- Deliğe su tutma – Duru su geleceye kadar deliğe su hortumu ile normal şebeke basıncında su tutunuz.
- Önemli! Harç doldurmadan önce delikteki suyu temizleyiniz ve tam olarak kuruyana kadar yağ içermeyen basınçlı hava tutunuz (Su altındaki uygulamalarda kırıcı - delici ile açılan deliklere uygulanmaz).

### ⚠ Hava boşluğu oluşmaması için deliği doldurma işleminin, delik tabanından başladığından emin olunuz.

- Delik tabanına ulaşmak için gerekirse uzatmaları kullanınız.
- Baş hizasının üzerindeki uygulamalar sırasında HIT-SZ/IP aksesuarını kullanınız ve sabitleme elemanlarını yerleştirirken dikkat ediniz. Fazla harç delikten taşabilir. Uygulayıcının üzerine harç damlamadığından emin olunuz.
- Önceden açılmış folyo tüpe yeni bir karıştırıcı monte edilirse, ilk strok değerlerini göz ardı ediniz.
- Her yeni folyo tüp için yeni bir karıştırıcı kullanınız.

### ⚠ Talimatlara uyulmaması, sabitlemenin bozulmasına neden olabilir!

## 用于在混凝土中固定钢筋和锚的胶粘剂锚固系统

▶ 在使用产品之前，应遵守使用说明和法律规定的安全预防措施。

### Hilti HIT-RE 500

包含: 2,2'-[(1-甲基亚乙基)双(4,1-亚苯氧基亚甲基)]双环氧乙烷 (A); 苯酚与甲醛和缩水甘油醚的聚合物 (A), 2-乙基-2-(羟甲基)-1,3-丙二醇与氯甲基环氧乙烷的聚合物 (A), 1,3-间苯二甲胺 (B)



(A,B)



(A,B)



(A)



(A)



### 危险

- H314 造成严重皮肤灼伤和眼损伤。(A, B)  
 H317 可能导致皮肤过敏反应。(A, B)  
 H341 怀疑可造成遗传性缺陷。(A)  
 H360 可能对生育能力或胎儿造成伤害。(A)  
 H411 对水生生物有毒并具有长期持续影响。(A,B)

- P280 戴防护眼罩, 穿防护服, 戴防护手套  
 P262 严防进入眼中、接触皮肤或衣服。  
 P305+P351+P338 如进入眼睛: 用水小心冲洗几分钟。如戴隐形眼镜并可方便地取出, 取出隐形眼镜。继续冲洗。  
 P333+P313 如发生皮肤刺激或皮疹: 求医/就诊。  
 P337+P313 如仍觉眼刺激: 求医/就诊。  
 P302+P352 如有皮肤沾染: 使用大量水清洗。

### 推荐的防护装备:

**眼睛防护:** 紧密密封的安全眼镜; 例如: # 02065449 安全眼镜 PP EY-CA NCH 清晰; # 02065591 护目镜 PP EY-HA R HC/AF 清晰;

**手部防护:** EN 374 / EN 388 ; 通过组织措施避免直接接触化学品/产品/制剂。

最终选择适当的防护装备是用户的责任

### 废弃处理方法

#### 空桶:

▶ 或按照垃圾分类手册 EAK 废物代码 15 01 06 (混合的包装材料) 进行废弃处理。

#### 完全或仅部分排空的包装:

▶ 按照官方法规作为特殊废物进行废弃处理。

- 垃圾分类手册 EAK 废物代码: 20 01 27\* 油漆、墨水、胶粘剂和包含危险物质的树脂。
- 或废物代码: EAK 08 04 09\* 含有有机溶剂或其它危险物质的废弃胶粘剂和密封剂。

含量: 330 毫升 / 11.1 液态盎司

500 毫升 / 16.9 液态盎司

重量: 475 克 / 16.7 盎司

723 克 / 25.5 盎司

喜利得公司对由于下列原因引起的损坏或故障将不承担任何责任：

- 未按照规定条件进行存储和运输。
- 未遵守有关使用和安装数据的说明，使用不正确
- 锚固点设计不充分，基材承载能力不足
- 喜利得公司不了解的或喜利得公司无法控制的 其它影响，例如使用了第三方的产品。

## 产品信息

- 应始终将本使用说明与产品保存在一起。
- 当您产品交给他人时，请确保一并交付本使用说明。
- **材料安全数据表：**使用前应仔细察看材料安全数据表。
- **检查产品有效期：**参见锡箔包连接头上的有效期印记(月/年)。切勿使用过期产品。
- **使用期间的锡箔包温度：**在 +5 °C 至 40 °C / 41 °F 至 104 °F 之间。
- **运输和存储条件：**存放在阴凉、干燥处，避光保存，温度在 +5 °C 至 25 °C / 41 °F 至 77 °F 之间。
- 对于本文件未涉及的任何应用场合/规定范围以外的数值，请与喜利得公司联系。
- **未完全用完的锡箔包必须在四周内用完。**将混合嘴保持安装在锡箔包连接头上，并存放在推荐的存储条件下。如再次使用，应连接一个新的混合嘴，并废弃刚混合的锚固胶粘剂量。

CN

## 警告



**▲ 不适当的处理，可能会导致砂浆飞溅。眼睛接触到砂浆可能会导致永久的视力损害！**

- 在处理砂浆前，应始终穿戴严密的护目镜、手套和防护服！
- 在混合嘴未适当旋上时，切勿开始注射。
- 在注射新的锡箔包之前，应连接新的混合嘴(两者必须完全密合)。
- 小心：切勿在锡箔包系统处于压力之下时拆除混合嘴。按下注射器的释放按钮以避免砂浆飞溅。
- 当使用加长软管时：必须只能通过附带的混合嘴(而不是通过加长软管)排出最初使用的砂浆流。
- 只能使用与粘结砂浆一起提供的混合嘴类型且只能给混合嘴供应粘结砂浆。不要以任何方式改变混合嘴。
- 切勿使用损坏的锡箔包和/或损坏的或不清洁的锡箔包套筒。

**▲ 钻孔清洁不够会引起锚固点负荷数值不良/潜在失效。**

- 喜利得 TE-CD、TE-YD 空心钻头必须搭配正确维护的喜利得吸尘器使用，吸尘器型号与抽吸能力(容积流量)在配件表格中有详述
- 在注入粘结砂浆之前，钻孔内必须干燥并且不得有灰尘、水、碎屑、冰、油、油脂或者其它污染物。
- 对于钻孔吹气—用不含油的空气吹气，直至返回的气流无可见的灰尘。
- 若要刷洗钻孔清洁—请仅使用指定的钢丝刷。必须确保钢丝刷不会穿入钻孔—否则即表示钢丝刷过小，必须予以更换。
- 对于钻孔冲洗—用水管压力冲洗，直至流出来的水变得清澈。
- 重要提示！在注入砂浆之前，将水全部从钻孔中清除并用无油压缩空气吹气，直到钻孔完全变干(适用于水下应用中的锤击钻孔)。

**▲ 确保从钻孔底部开始加注(避免形成气隙)。**

- 必要时，可使用配件/加长件，以达到钻孔底部。
- 对于垂直头顶应用场合，请使用垂直头顶配件 HIT-SZ / IP，并在插入锚固元件时要特别小心。注意过多的粘结砂浆可能会从钻孔中压出。确保没有砂浆滴到锚固装置上。
- 如果将新的混合嘴安装在先前打开的锡箔包上，则必须废弃第一次扣动扳机时喷出的砂浆。
- 每一个新的锡箔包都必须使用一个新的混合嘴。

**▲ 不遵守这些安装说明可能会造成固定点损坏！**

## 用於混凝土中固定鋼筋及安卡的黏著安卡系統

► 使用產品前，請遵守使用操作說明，以及法律規定之安全預防措施。

### Hiti HIT-RE 500

包含：2,2'-(1-甲基亚乙基)双(4,1-亚苯氧基亚甲基)双环氧乙烷 (A); Formaldehyde, oligomeric reaction products with 1-chloro-2,3-epoxypropane and phenol (A); Trimethylolpropane triglycidylether (A); 間二甲苯二胺 (B);



### 危險

- H314 引起嚴重的皮膚灼傷和眼睛損傷 (A,B)  
H317 可能引起皮膚過敏性反應(A,B)  
H341 懷疑造成遺傳性缺陷。(A)  
H360 可能對生育能力或對胎兒造成傷害 (A)  
H411 對水生生物有毒並具有長期持續影響 (A,B)

P280 戴防護手套/穿防護服/戴防護眼罩/戴防護面具。

P262 嚴防進入眼中、接觸皮膚或衣服沾汙。

P302+P352 如皮膚沾染：用大量肥皂和水清洗

P305+P351+P338 如進入眼睛：用水小心沖洗幾分鐘。如戴隱型眼鏡並可方便地取出，取出隱型眼鏡。繼續沖洗。

P333+P313 如發生皮膚刺激或皮疹：求醫/就診。

P337+P313 如仍覺眼刺激：求醫/就診

### 建議保護裝備：

**眼睛保護：**密閉的安全眼鏡，例如編號02065449透明安全眼鏡PP EY-CA NCH；編號02065591透明護目鏡PP EY-HA R HC/AF；

**防護手套：**EN 374 / EN 388；手套材質：腈橡膠 (NBR)，採取規定措施，避免直接接觸化學物質 / 產品 / 製品。

選用適當的防護裝備為使用者之責任

### 廢棄處置

#### 空鉛箔包：

► 或按照EAK廢料法 15 01 02 塑膠包裝回收。

#### 全滿 / 半滿的鉛箔包：

► 依照政府規定進行特殊廢棄物的廢棄處置。

- EAK廢料法：20 01 27\* 漆、墨、膠黏劑與含危險成份的樹脂。

- 或廢料法：EAK 08 04 09\* 廢棄膠黏劑與含有機溶劑或其他危險成份的密封劑。

容量： 330 ml / 11.1 fl.oz

500 ml / 16.9 fl.oz

重量： 475g / 16.7 oz

723g / 25.5 oz

Hilti對於以下原因所造成的損害或故障不負任何責任：

- 未按照指定條件進行貯放和搬運。
- 未遵循使用及設定資料的說明，而未正確使用。
- 中心軸點設計不正確，基材負載能力不足
- Hilti公司未知或無法改變的其他影響，例如搭配使用第三方的產品。

## 產品資訊

- 請將本使用說明書與產品一同存放。
- 機具轉交給他人時，必須連同本使用說明書一起轉交。
- 物質安全資料表：使用前請先參閱MSDS。
- 檢查到期日：參見錫箔包裝相關位置的使用期限（月份 / 年份）。請勿使用已過期的產品。
- 使用期間的錫箔藥劑包溫度：+5 °C到40 °C / 41 °F到104 °F。
- 搬運及貯放條件：置於陰涼、乾燥及陰暗場所，溫度保持在+5 °C到25 °C / 41 °F到77 °F之間。
- 若有任何本文件沒有包含的應用情況 / 超出指定的數值，請聯絡Hilti。
- 未用完的錫箔藥劑包應置於於盒中並在四週內用完。將混合器留在錫箔藥劑包歧管上並存放在建議的儲存條件下。若經過重複使用，裝上新的混合器，並捨棄安卡黏著劑的初次使用量。

zh

### 警告



**▲ 錯誤處理可能會導致植筋劑噴濺。植筋劑如果接觸眼睛可能會造成無法復原的傷害！**

- 開始處理植筋劑前，務必戴上密著式的護目鏡、手套及防護衣。
- 混合器未緊緊鎖上前，切勿開始注射。
- 注射新錫箔藥劑包前先安裝新的混合器（確保緊密安裝）。
- 注意！在錫箔藥劑包仍處於壓力下時，不得拆下混合器。按下注射器上的釋放按鈕以避免植筋劑噴濺。
- 使用延長管時：必須透過隨附的混合器去除開始使用時的植筋劑。
- 僅能使用黏著劑隨附的混合器類型。不可修改混合器的任何地方。
- 絕對不可使用受損的錫箔包與受損或不乾淨的錫箔藥劑包套筒。

**▲ 孔洞未妥善清潔造成較差的負載值或是固定點可能會故障。**

- 喜利得空心鑽頭 TE-CD, TE-YD 必須配合得到正確保養的喜利得吸塵機使用，其型號和抽吸能力（體積流量）列於附表
- 黏著劑注射前，孔洞必須保持乾燥且沒有碎片、粉塵、水、冰、油、油脂和其他污染物。
- 孔洞吹風清潔 – 以無油空氣吹風，直到回風沒有可見的粉塵為止。
- 孔洞刷洗清潔 – 務必使用指定的鐵刷。孔洞大小應能抵住鐵刷，如果鐵刷小於孔洞則必須更換。
- 孔洞清洗清潔 – 以加壓水沖洗，直到流出的水乾淨為止。
- 重要資訊！注射植筋劑前必須清除孔洞中的水分，並使用無油壓縮空氣完全吹乾（不適用於水中的鎚擊鑽孔）。

**▲ 確保孔洞由後方填滿，而沒有出現空隙。**

- 如有需要，可使用配件 / 延長線清理孔洞後方。
- 若使用於高處，請使用高處配件HIT-SZIP，並於置入固定元件時請特別小心。多餘的黏著劑可能會被擠出孔洞。請確定沒有植筋劑滴落在安裝人員身上。
- 若要将新的混和器安裝至先前已開啟過的錫箔包上，必須丟棄第一個注射控制鈕。
- 新的錫箔包必須使用新的混合器。

**▲ 不遵守這些安裝說明可能會造成固定點損壞！**

**콘크리트 고정용 철근 및 핀 연결 모르타르 시스템**

▶ 사용 전에 본 사용설명서를 숙독하고 안전규칙을 준수한다.

**Hilti HIT-RE 100**

포함: 비스페놀 A 다이글리시딜 에테르 (A); Formaldehyde, oligomeric reaction products with 1-chloro-2,3-epoxypropane and phenol (A); Trimethylolpropane triglycidylether (A); m-자일렌다이아민 (B);



(A,B)



(A,B)



(A)



(A)



**위험**

- H314 피부에 심한 화상과 눈에 손상을 일으킴 (A,B)
- H317 알레르기성 피부 반응을 일으킬 수 있음 (A,B)
- H341 유전적인 결함을 일으킬 것으로 의심됨 (A)
- H360 태아 또는 생식능력에 손상을 일으킬 수 있음 (A)
- H411 장기적인 영향에 의해 수생생물에게 유독함(A,B)

P280 보호장갑·보호의·보안경·안면보호구를 착용하십시오.  
P262 눈, 피부, 의복에 묻지 않도록 하시오.

P302+P352 피부에 묻으면 다량의 물과 비누로 씻으시오.

P305+P351+P338 눈에 묻으면 몇 분간 물로 조심해서 씻으시오. 가능하면콘택트렌즈를 제거하십시오. 계속 씻으시오.

P333+P313 피부자극성 또는 홍반이 나타나면 의학적인 조치·조언을 구하십시오.

P337+P313 눈에 자극이 지속되면 의학적인 조치·조언을 구하십시오.

**권장 보호장비:**

눈 보호: 꼭 조 이 는 보 안 경 예.: #02065449 보안경 PP EY-CA NCH 클리어; #02065591 보안경 PP EY-HA R HC/ AF 클리어;

손 보호: EN 374 / EN 388; 조직차원의 조치를 통해 조제 시 화학물질 / 제품과의 직접적인 접촉을 피해주시길 바랍니다.

적절한 보호장비의 최종 결정은 사용자 책임입니다.

**폐기 지침**

**빈 용기**

▶ 또는 EAK 폐기물 코드: 15 01 02플라스틱 포장재

완전히/부분적으로 비어 있는 용기:

▶ 당국의 규정에 유의하여 위험폐기물로 구분하여 폐기처리한다.

- EAK 폐기물 코드: 20 01 27\* 유독물질을 함유한 페인트, 인쇄용 잉크, 접착제, 합성 수지
- 또는 EAK 폐기물 코드: 08 04 09\* 유기용매 또는 기타 유독물질을 함유한 접착제 및 실러 폐기물

내용물: 330 ml / 11.1 fl. oz

500 ml / 16.9 fl. oz

무게: 475g / 16.7 oz

723g / 25.5 oz

Hilti는 다음과 같은 경우로 인해 발생한 손상에 대해 어떠한 책임도 지지 않는다.

- 규정을 어긴 보관 및 운반 조건
- 사용설명서 및 도면 무시
- 마운팅 측정 불충분함, 모재의 하중지지능력 부족함
- 예를 들어 타사제품 사용과 같이 Hilti가 알지 못하는 또는 Hilti가 대변할 수 없는 기타 영향

#### 제품 정보

- 본 사용설명서를 항상 제품과 함께 보관한다.
- 제품을 타인에게 넘겨줄 경우 반드시 사용설명서를 함께 전달한다.
- 안전자료: 작업 전에 안전자료에 유의한다.
- 유효기간: 용기 연결부에 있는 유효기간(월/연도)을 확인한다. 유효기간이 지난 제품을 사용해서는 안 된다.
- 사용중 용기 온도: +5 °C - 40 °C / 41 °F - 104 °F
- 운반 및 보관 조건: 건조하며 서늘하고 어두운 곳에서 +5 °C - 25 °C / 41 °F - 77 °F 온도에 보관.
- 기존 사용설명서에서 다루지 않은 방법은 사용하지 않습니다. Hilti에 문의한다.
- 쓰고 남은 용기는 4 주 이내에 다시 사용해야 한다. 연결 상태의 믹서는 그대로 두고 용기는 규정에 따라 보관한다. 계속해서 사용 시 새로운 믹서를 볼트로 연결하고 처음 흘러나온 모르타르는 폐기한다.

#### ⚠ 경고



⚠ 취급 방법이 올바르지 않을 경우 모르타르가 분사될 수 있다.

모르타르가 눈에 닿은 경우 눈에 손상을 가져올 수 있다!

- 작업 시에는 누설되지 않는 보안경, 보호장갑 및 작업복을 착용한다
- 믹서를 제대로 장착하지 않은 상태에서 절대 압착을 시작하지 않는다!
- 새 용기를 압착하기 전에 새로운 믹서를 연결한다. 단단히 고정시키도록 주의한다.
- 주의! 시스템이 압력을 받는 상태에서 절대로 믹서를 풀지 않는다. 모르타르가 분사되지 않도록 먼저 기기에서 잠금해제 노브를 누른다.
- 연장 호스 사용 시: 처음 흘러나온 모르타르는 제공된 믹서를 통해서만 폐기한다(연장 호스를 통해서 하면 안 됨).
- 모르타르와 함께 제공된 믹서모델만을 사용한다. 어떠한 환경에도 믹서를 변형시켜서는 안 된다.
- 절대 손상된 포장용기 그리고/또는 손상되거나 오염된 카트리지를 사용해서는 안 된다.

⚠ 천공구멍 세척이 충분히 이루어져 있지 않은 경우, 하중값이 부정확하고 고정이 안 될 수 있다.

- Hilti 중공 드릴 비트 TE-CD, TE-YD는 액세서리 테이블에 명시된 모델 및 흡입 용량(유적 유량)을 갖춘 적절한 관리된 힐티 진공 청소기와 함께 사용해야 합니다
- 모르타르 분사 전에 천공 구멍을 건조시키고, 남아 있는 부스러기, 먼지, 물기, 얼음, 오일, 그리스 또는 기타 이물질을 제거해야 한다.
- 천공구멍 볼러내기-천공구멍을 오일기가 없는 공기로 볼러내며, 역류하는 공기에 먼지가 포함되어 있지 않을 때까지 계속 실행한다.
- 천공구멍을 브러시로 청소하기 - 적합한 스틸 와이어 브러시만 사용한다. 천공구멍을 브러시로 청소할 때 브러시에서 저항이 느껴져야 한다. 그렇지 않을 경우에는 브러시가 너무 작아서 브러시를 교체해야 한다.
- 천공구멍 세척하기-맑은 물이 흘러 나올 때까지 물 호스를 사용하여 일반 수압으로 천공구멍을 세척한다.
- 중요! 모르타르를 채우기 전에 천공구멍에서 물을 제거하고 완전히 건조될 때까지 오일기가 없는 공기로 볼러낸다(수중 사용시 해머 드릴 구멍에는 적용되지 않음).

⚠ 기포가 생성되지 않도록 천공구멍 바닥부터 천공구멍이 채워지는지 확인한다.

- 필요에 따라 천공구멍 바닥에 도달하기 위해 연장부를 사용한다.
- 천장 작업 시 HIT-SZ/IP 액세서리를 사용하고 특히 고정 요소 삽입 시 주의한다. 모르타르가 과도하게 사용되면 모르타르가 천공구멍 밖으로 새어 나올 수 있다. 모르타르가 사용자에게 떨어지지 않는지 확인한다.
- 이미 개봉된 용기에 새로운 믹서를 연결시킬 경우, 마찬가지로 방아쇠를 당겨 처음 배출되는 모르타르를 폐기한다.
- 새로운 용기에는 항상 새로운 믹서를 사용해야 한다.

⚠ 지침에 유의하지 않을 경우 고정작업이 실패할 수 있다.

لا تتحمل شركة Hilti مسؤولية الأضرار الناتجة عن:

- ظروف التخزين والنقل المخالفة للتعليمات
- عدم مراعاة تعليمات الاستخدام وبيانات الترسخ وسوء الاستخدام
- التقدير غير الكافي لتجهيزات التثبيت، قدرة التحمل غير الكافية للجدار
- المؤثرات الأخرى غير المعروفة لدى شركة Hilti أو التي لا دخل لشركة Hilti بها، كاستخدام منتجات أخرى مثلاً.

### معلومات المنتج

- احتفظ دائماً بإرشادات الاستخدام هذه مع المنتج.
- ولا تقم بتسليم المنتج لأشخاص آخرين إلا مع إرفاق إرشادات الاستخدام به.
- نشرة بيانات السلامة: تراعى نشرة بيانات السلامة قبل الشروع في العمل.
- تاريخ الصلاحية: راجع تاريخ الصلاحية (الشهر/السنة) المطبوع على ثنية الوصل بالعبوة. ولا يجوز استخدام المنتج بعد انتهاء تاريخ الصلاحية.
- درجة حرارة العبوة أثناء الاستخدام: ٥+ °م / ٤٠ °م / ٤١ °م حتى ١٠٤ °م.
- شروط النقل والتخزين: في مكان بارد وجاف ومظلم عند ٥+ °م حتى ٢٥ °م / ٤١ °م حتى ٧٧ °م.
- بالنسبة للتطبيقات التي لم يتم شرحها في إرشادات الاستخدام هذه أو التي تخالف المواصفات، يرجى الاتصال بشركة Hilti.
- في حالة استخدام خرطوم تطويل: تخلص من مقدمة الملاط من خلال الخلاط المورد فقط (وليس من خلال خرطوم التطويل).
- الأنبوب التي لم تستهلك محتوياتها بالكامل يجب استخدامها خلال أربعة أسابيع. ويلزم ترك الخلاط مركباً وتخزين الأنبوب بطريقة صحيحة. وعند مواصلة استخدام الأنبوب يلزم تركيب خلاط جديد والتخلص من الكمية الأولى للملاط.



### تحذير

▲ في حالة الاستخدام غير المطابق للتعليمات قد يتطاير رذاذ من الملاط. ويمكن أن تؤدي ملامسة الملاط للعينين إلى حدوث أضرار بالعينين.

- احرص أثناء العمل على ارتداء نظارة واقية محكمة العلق وقفاز واق لليدين وملابس مناسبة لطبيعة العمل!
- لا تشرع أبداً في عملية الحقن دون ربط الخلاط.
- قبل تفريغ محتويات أنبوب جديد يجب ربط خلاط جديد. يراعى التأكد من إحكام التثبيت.
- احترس! لا تقم أبداً بفك الخلاط إذا كان النظام واقعا تحت ضغط. واضغط قبل ذلك على زر التحرير بالجهز لتجنب تطاير رذاذ من الملاط.
- اقتصر على استخدام نوع الخلاط المورد مع الملاط. ولا تقم بإجراء تعديلات على الخلاط بأي حال من الأحوال.
- لا تستخدم أبداً أنبوباً تالفاً و/أو خراطيش تالفة أو متسخة.

▲ تزدني قوى التثبيت/فشل عملية التثبيت بسبب النظافة غير الكافية للتعب. قبل الحقن يجب تنظيف الثقب من أية شوائب ناتجة عن

- عملية الثقب أو أتربة أو ماء أو تلعج أو زيوت أو شحوم أو أية اتساخات أخرى.
- يجب استخدام لقم حفر الخواخيش TE-CD و TE-YD من Hilti مع شفاط هواء Hilti محفوظ بشكل صحيح بالاطار وقدره النا
- تنظيف الثقب من خلال النفخ - انفع الثقب بتيار هواء خالٍ من الزيت إلى أن يخرج الهواء من الثقب خالياً من الأتربة.
- شطف الثقب - اشطف الثقب باستخدام خرطوم ماء بالضغط المعتاد لشبكة المياه إلى أن ينساب ماء نقي من الثقب.
- هام! قبل ملء الثقب بالملاط يجب إزالة الماء من الثقب وتنظيفه من خلال النفخ بالهواء المضغوط الخالي من الزيت، إلى أن يصبح الثقب جافاً تماماً (لا يسري على الثقب التي يتم عملها بالمنقاب المطرقي في تطبيقات الاستخدام تحت الماء).

▲ تأكد أن عملية ملء الثقب بالملاط تبدأ من قاع الثقب، كي لا تتكون فقاعات هواء بداخله.

- عند الضرورة استخدم لهذا الغرض وسائل إطالة للوصول إلى قاع الثقب.
- في حالة القيام بتطبيقات فوق مستوى الرأس استخدم الملحق التكميلي HIT-SZ/IP وتوخ الحذر الشديد عند إدخال عنصر التثبيت. فقد يخرج الملاط الفائض من الثقب. لذا تأكد من عدم تساقط الملاط على المستخدم.
- في حالة ربط خلاط جديد على أنبوب مفتوح بالفعل، قم أيضاً بالتخلص من الكمية الأولى للملاط.
- يجب استخدام خلاط جديد مع كل أنبوب جديد.

▲ يمكن ان يؤدي عدم مراعاة التعليمات إلى فشل عملية العبيسا!



ملاط التثبيت لأعمال تثبيت أسياخ الحديد والخوابير في الخرسانة  
 ◀ احرص قبل الاستعمال على قراءة إرشادات الاستخدام هذه والالتزام بتعليمات الأمان.

## Hilti HIT-RE 100

**Contains:** 2,2'-[(1-methylethylidene)bis(4,1-phenyleneoxymethylene)]bisoxirane (A); Formaldehyde, oligomeric reaction products with 1-chloro-2,3-epoxypropane and phenol (A); Trimethylolpropane triglycidylether (A); m-Xylylenediamine (B);



(A,B)

(A,B)

(A)

(A)  
خطر

H314 يسبب حروقا جلدية شديدة وتلفا للعين. (A,B)

H317 قد يسبب تفاعلا للحساسية في الجلد. (A, B)

H341 يشتبه بأنه يسبب عيوباً جنينية (A)

H360 قد يتلف الخصوبة أو الجنين (A)

H411 سمي للحياة المائية مع تأثيرات طويلة الأمد. (A,B)

P280 توضع قفازات حماية/ملايس حماية/ وقاء للعينين/للوجه.

P262 يلزم تجنب ملامسة المنتج للعين أو الجلد أو الملايس..

P302+P352 في حالة السقوط على الجلد : يغمر بوفرة من الصابون والماء.

P305+P351+P338 في حالة دخول العين: تشطف باحتراس بالماء لعدة دقائق. تنزع العدسات اللاصقة إذا كان ذلك أمرا سهلا. يستمر الشطف.

P333+P313 إذا حدث تهيج أو طفح جلدي: تطلب استشارة الطبيب/الرعاية الطبية

P337+P313 إذا استمر تهيج العين: تطلب استشارة الطبيب/الرعاية الطبية.

تجهيزات الحماية الشخصية الموصى بها:

واقية للعينين: نظارة حماية محكمة الغلق، مثل #02065449 نظارة الأمان الصافية PP EY-CANCH #02065591 والنظارة الصافية

PP EY-HA R HC/AF

قفازات حماية: EN 388 / EN 374 خامة القفازات: مطاط النتريل، يجب تجنب التلامس المباشر مع الكيماويات/المنتج/المستحضرات عبر إجراءات تنظيفية.

الاختيار النهائي لتجهيزة الحماية المناسبة مسؤولية مستخدم

إرشادات التخلص من النفايات

العبوة الفارغة

◀ أو كود المخلفات EAK: 15 01 06 عيوب التغليف المختلطة.

العبوة المملوءة/الفارغة جزئيا: 150102 للعبوة البلاستيكية

◀ قم بالتخلص منها مع مراعاة التعليمات الرسمية باعتبارها مخلفات ذات طبيعة خاصة.

- كود المخلفات EAK: 20 01 27\* للألوان واللوان الطباعة والمواد اللاصقة والأصماغ الصناعية التي تحتوي على مواد خطيرة.

- أو كود المخلفات EAK: 08 04 09\* لنفايات المواد اللاصقة و مواد الإحكام التي تحتوي على مذيبات عضوية أو غيرها من المواد الخطيرة.

٥٠٠ مليلتر/ ١٦,٩ أونس سائل

٧٢٣ جم/ ٢٥,٥ أونس

المحتوى: ٣٣٠ مليلتر/ ١١,١ أونس سائل

الوزن: ٤٧٥ جم/ ١٦,٧ أونس

## Sistem penambatan perakat untuk bar tetulang dan pengikatan penambatan dalam konkrit

► Sebelum menggunakan produk, ikuti arahan untuk penggunaan dan langkah keselamatan yang diwajibkan undang-undang.

### Hiti HIT-RE 100

**Mengandungi:** 2,2'-[(1-methylethylidene)bis(4,1-phenyleneoxymethylene)]bisoxirane (A); Formaldehyde, oligomeric reaction products with 1-chloro-2,3-epoxypropane and phenol (A); Trimethylolpropane triglycidylether (A); m-Xylylenediamine (B);



(A,B)



(A,B)



(A)



(A)



### Bahaya

H314 Menyebabkan luka terbakar pada kulit dan kerosakan mata yang teruk.(A,B)

H317 Boleh menyebabkan tindak balas kulit alahan.(A,B)

H341 Disyaki menyebabkan kecacatan genetik. (A)

H360 Boleh merosakkan kesuburan atau janin (A)

H411 Toksik kepada hidupan akuatik dengan kesan berpanjangan.(A,B)

P280 Pakai sarung tangan pelindung/pakaian pelindung/perlindungan mata/perlindungan muka.

P262 Jangan biarkan terkena mata, kulit atau pakaian.

P302+P352 JIKA TERKENA KULIT: Basuh dengan sabun dan air yang banyak.

P305+P351+P338 JIKA TERKENA MATA: Bilas berhati-hati dengan air selama beberapa minit. Tanggalkan kanta lekap, jika ada dan mudah berbuat demikian. Teruskan membilas.

P333+P313 Jika berlaku kerengsaan kulit atau ruam: Dapatkan nasihat/rawatan perubatan.

P337+P313 Jika kerengsaan mata berterusan: Dapatkan nasihat/rawatan perubatan.

### Peralatan pelindung yang disyorkan:

**Pelindung mata:** Kaca mata keselamatan yang kedap cth.: #02065449 Kaca mata keselamatan PP EY-CA NCH jernih; #02065591 Gogal PP EY-HA R HC/AF jernih;

**Sarung tangan pelindung:** EN 374 / EN 388; Material sarung tangan: Getah nitril, NBR Elakkan sentuhan secara langsung dengan bahan kimia/ produk/ penyediaan tersebut melalui langkah-langkah teratur.

**Pemilihan terakhir untuk peralatan pelindung yang sesuai adalah tanggungjawab pengguna**

### Pertimbangan pelupusan

#### Bungkusan kosong

► kod bahan buangan 15 01 02 pembungkusan plastik

#### Bungkusan penuh atau separuh kosong:

► lupuskan sebagai buangan khas menurut peraturan rasmi.

– Kod bahan buangan EAK: 20 01 27\* cat, dakwat, perakat dan resin mengandungi bahan berbahaya.

– atau kod bahan buangan: EAK 08 04 09\* perakat buangan dan pengedap yang mengandungi pelarut atau bahan berbahaya lain.

**Kandungan:** 330 ml / 11.1 fl. oz

500 ml / 16.9 fl. oz

**Berat:** 475g / 16.7 oz

723g / 25.5 oz

Hilti tidak menerima apa-apa liabiliti untuk kerosakan atau kegagalan disebabkan oleh:

- Simpanan dan pengangkutan tidak menurut syarat yang dinyatakan.
- Kegagalan untuk mematuhi arahan penggunaan dan menetapkan data, salah penggunaan
- Reka bentuk titik sauh tidak mencukupi, keupayaan membawa beban asas tidak mencukupi
- Pengaruh lain yang mana Hilti tidak sedar atau yang mana Hilti tidak mempunyai pengaruh cth. gunakan dengan daripada pihak ketiga.

## Maklumat produk

- Sentiasa simpan arahan ini untuk penggunaan bersama dengan produk.
- Pastikan arahan untuk penggunaan berada dengan produk apabila diberi kepada orang lain.
- Risalah Data Keselamatan Bahan: Tinjau MSDS sebelum mengguna.
- Periksa tarikh tamat tempoh: Lihat tarikh tamat tempoh tertera di manifold bungkusan kerajang (bulan/tahun). Jangan gunakan produk tamat tempoh.
- Suhu bungkusan kerajang semasa penggunaan: +5 °C / 41 °F hingga 40 °C / 104 °F.
- Syarat untuk pengangkutan dan penyimpanan: Simpan di tempat dingin, kering dan gelap antara +5 °C hingga 25 °C / 41 °F hingga 77 °F.
- Untuk apa-apa aplikasi tidak dirangkumi oleh dokumentasi ini/melampaui nilai dinyatakan, sila hubungi Hilti.
- Bungkusan kerajang yang digunakan sebahagiannya mesti disimpan dalam kaset dan perlu digunakan dalam tempoh 4 minggu. . Biarkan pengadun yang dipasang pada berbagai bungkusan kerajang dan simpan di bawah keadaan menyimpan yang dicadangkan. Jika digunakan semula, pasang pengadun baru dan buang kuantiti permulaan perekat penambatan.

## AMARAN



MS

### ⚠ Pengendalian tidak betul boleh menyebabkan mortar terpeclak. Sentuhan mata dengan mortar boleh menyebabkan kerosakan mata tidak dapat dibalikkan seperti sedia kala!

- Sentiasa pakai cermin mata keselamatan dikedap ketat, sarung tangan dan pakaian perlindungan sebelum mengendalikan mortar!
- Jangan sekali-kali mulakan mendispens tanpa pengadun diskrukan dengan betul.
- Hanya gunakan jenis pengadun yang dibekalkan dengan perekat. Jangan mengubahsui pengadun dengan apa-apa cara.
- Amaran! Jangan sekali-kali alihkan pengadun semasa sistem bungkusan kerajang berada di bawah tekanan. Tekan butang pelepas pada pendispens bagi mengelakkan mortar daripada terpercik.
- Apabila menggunakan hos tambahan: Pembuangan aliran mortar awal mestilah dilakukan melalui pengadun yang dibekal sahaja (bukan melalui hos sambungan).
- Jangan sekali-kali gunakan bungkusan kerajang rosak dan/atau pemegang rosak atau bungkusan kerajang tidak bersih.

### ⚠ Nilai beban rendah/potensi kegagalan titik pengikatan disebabkan pembersihan lubang jara tidak mencukupi.

- Mata gerudi berongga Hilti TE-CD, TE-YD mesti digunakan bersama pembersih vakum Hilti yang diselenggara dengan baik yang mempunyai model dan keupayaan sedutan (kadar aliran isi padu) seperti yang ditetapkan dalam jadual aksesori
- Lubang jara mestilah bersih daripada serpih-serpihan, habuk, air, ais, minyak, gris dan bahan cemar lain sebelum suntikan perekat.
- Untuk meniup keluar daripada lubang – tiup keluar dengan udara tanpa minyak sehingga kembali aliran udara adalah bebas daripada habuk yang ketara.
- Untuk memberus lubang gerak – hanya gunakan berus dawai yang dinyatakan. Berus mestilah tahan penyisipan ke dalam lubang gerak
- Untuk mencurah air ke lubang jara – curah dengan tekanan talian air sehingga air berjalan lancar.
- Penting! Keluarkan semua air dari lubang jara dan sembur menggunakan udara mampat bebas minyak sehingga lubang jara benar-benar kering sebelum menyuntik mortar (tidak terpakai untuk lubang yang digerudi penukul dalam kegunaan bawah air).

### ⚠ Pastikan lubang jara dilisikan dari belakang lubang jara tanpa membentuk lubang udara.

- Jika perlu, gunakan aksesori/sambungan untuk sampai ke belakang lubang jara.
- Untuk aplikasi atas gunakan aksesori atas HIT-SZ/IP dan berhati-hati apabila memasukkan elemen mengikat. Perekat berlebihan mungkin dipaksa keluar dari lubang jara. Pastikan tiada mortar titis ke dalam pemasangan.
- Jika pengadun baru dipasang ke dalam bungkusan kerajang yang dibuka sebelum ini, tarikan picu pertama mesti dibuang.
- Pengadun baru mesti digunakan untuk setiap bungkusan kerajang baru.

### ⚠ Tidak mematuhi kepada arahan seting ini boleh mengakibatkan kegagalan titik pengetatan!

**Hệ thống neo cấy dùng keo để củng cố cốt thép và neo cấy vào bê tông**

► Trước khi sử dụng, xin vui lòng theo đúng hướng dẫn sử dụng và các biện pháp an toàn bắt buộc về mặt luật pháp.

**Hilti HIT-RE 100**

Contains: 2,2'-[(1-methylethylidene)bis(4,1-phenyleneoxymethylene)]bixoxirane (A); Formaldehyde, oligomeric reaction products with 1-chloro-2,3-epoxypropane and phenol (A); Trimethylolpropane triglycidylether (A); m-Xylylenediamine (B);



(A,B)



(A,B)



(A)



(A)

**Nguy hiểm**

H314	Gây bỏng da nghiêm trọng và nguy hiểm cho mắt.(A,B)
H317	Có thể gây ra phản ứng dị ứng da.(A,B)
H341	Bị nghi ngờ có thể gây khuyết tật di truyền (A)
H360	Có thể gây hại cho khả năng sinh sản và bào thai (A)
H411	Gây độc cho sinh vật thủy sinh, gây hại lâu dài (A,B)

P280 Đeo găng tay bảo vệ/mặc quần áo bảo hộ/dụng cụ bảo vệ mắt/bảo vệ mặt.

P262 Tránh tiếp xúc với mắt, da hoặc quần áo.

P302+P352 TRONG TRƯỜNG HỢP CÓ TIẾP XÚC VỚI DA: rửa lại với thật nhiều nước và xả phòng

P305+P351+P338 NẾU ĐÍNH MẮT: Rửa thật cẩn thận với nước trong vài phút. Tháo kính áp tròng nếu có và nếu dễ làm. Sau đó tiếp tục rửa

P333+P313 Nếu da bị dị ứng hoặc phát ban: Hãy xin chỉ dẫn của bác sĩ/thận trọng.

P337+P313 Nếu mắt vẫn bị kích ứng: Hãy xin chỉ dẫn của bác sĩ/thận trọng.

**Thiết bị bảo hộ lao động đề nghị:**

**Bảo vệ mắt:** Kính bảo hộ lao động kiểu kín, ví dụ: Kính bảo hộ lao động #02065449 PP EY-CA NCH không màu; Kính bảo hộ lao động #02065591 PP EY-HA R HC/AF không màu;

**Găng tay bảo hộ:** EN 374 / EN 388; Vật liệu găng: cao su nitril, NBR Tránh tiếp xúc trực tiếp với hóa chất/ sản phẩm/ việc chuẩn bị các biện pháp tổ chức.

**Người sử dụng có trách nhiệm lựa chọn cuối cùng về thiết bị bảo hộ lao động phù hợp**

**Các cân nhắc khi thải bỏ****Gói rỗng**

► mã phế liệu EAK bao bì nhựa 15 01 02

**Gói rỗng hoàn toàn hoặc một phần:**

► Phải được hủy bỏ như là một chất thải đặc biệt theo quy định của chính phủ.

- Mã phế liệu EAK: sơn, mực, keo và nhựa có ký hiệu 20 01 27\* chứa các thành phần nguy hiểm.

- hoặc mã phế liệu: hoặc keo và chất trám thái EAK 08 04 09\* chứa dung môi hữu cơ và các thành phần nguy hiểm khác.

**Hàm lượng:** 330 ml / 11.1 fl. oz

500 ml / 16.9 fl. oz

**Trọng lượng:** 475g / 16.7 oz

723g / 25.5 oz

Hilti không chịu trách nhiệm pháp lý cho các thiệt hại và hư hỏng gây ra do:

- Bảo quản và vận chuyển không đúng theo các điều kiện quy định.
- Không tuân thủ hướng dẫn sử dụng và các thông số đã định, sử dụng không đúng cách.
- Thiết kế các điểm neo không đầy đủ, khả năng chịu tải không đủ của vật liệu nền.
- Các ảnh hưởng khác mà Hilti không biết hoặc không có ảnh hưởng, ví dụ sử dụng sản phẩm của bên thứ ba.

#### Thông tin sản phẩm

- Luôn đính kèm hướng dẫn sử dụng này cùng với sản phẩm.
- Đảm bảo rằng hướng dẫn sử dụng luôn đi kèm sản phẩm thậm chí khi đã giao cho người khác.
- **Bảng dữ liệu an toàn hóa chất:** Xem lại bảng dữ liệu an toàn hóa chất trước khi sử dụng.
- **Kiểm tra ngày hết hạn:** Hãy xem ngày hết hạn in trên bao bì (tháng/năm). Không dùng sản phẩm hết hạn.
- **Nhiệt độ gói sản phẩm trong quá trình sử dụng:** +5 °C đến 40 °C/41 °F đến 104 °F.
- **Điều kiện vận chuyển và bảo quản:** Bảo quản ở nơi thoáng mát, khô ráo và tránh ánh sáng trong khoảng nhiệt độ +5 °C đến 25 °C/41 °F đến 77 °F.
- Đối với những áp dụng không ghi trong tài liệu này/vượt quá giá trị đã định, vui lòng liên hệ với Hilti.
- **Nếu sử dụng gói sản phẩm trong nhiều lần, phải sử dụng hết trong vòng một tuần.** Để vôi trộn kèm theo sản phẩm trong thiết bị bơm keo và đừng rút pit-tông ra! Tháo ống khí nén và bảo quản trong điều kiện bảo quản yêu cầu. Nếu dùng lại, gấn vôi trộn mới và bổ lượng hóa chất neo cây ban đầu.

#### CẢNH BÁO



#### **▲ Xử lý không chính xác có thể tạo ra các mảng vữa. Vữa khi tiếp xúc với mắt có thể gây ra những tổn thương không thể hồi phục!**

- Luôn mặc quần áo bảo hộ, mang găng tay, kính bảo vệ mắt kín trước khi xử lý vữa!
- Không pha trộn mà không có vôi trộn gắn đúng cách.
- Gắn vôi trộn mới trước khi pha trộn gói sản phẩm mới (đảm bảo vô khuẩn).
- Cảnh báo! Không được tháo vôi trộn khi hệ thống gói đang nén. Nhấn nút mở bộ trộn để tránh tạo ra các mảng vữa.
- Khi sử dụng ống mềm nối dài: việc loại bỏ dòng vữa ban đầu chỉ được thực hiện thông qua vôi trộn được cung cấp (không thông qua ống mềm nối dài).
- Chỉ dùng loại vôi trộn được cung cấp kèm theo hóa chất này. Không điều chỉnh vôi trộn dưới bất cứ hình thức nào.
- Không sử dụng gói đã hỏng và/hoặc đầu giữ gói bị hỏng hoặc dơ.

#### **▲ Giá trị tải trọng kém/không thể định vị các điểm do việc chưa làm sạch lỗ khoan.**

- Phải sử dụng mũi khoan lỗ rỗng Hilti TE-CD, TE-YD kết hợp với máy hút bụi Hilti được bảo trì đúng cách có môđen và công suất hút (định mức lưu lượng thể tích) như được quy định trong bảng phụ kiện
- Lỗ khoan phải khô và không có mảnh vụn, bụi, nước, nước đá, dầu, mỡ và các tạp chất khác bám vào trước khi bơm hóa chất.
- Để thổi sạch lỗ khoan - hãy thổi bằng khí không dầu cho đến khi luồng khí hồi không có bụi.
- Để phun nước rửa lỗ khoan - hãy phun bằng vòi áp lực đến khi thấy nước ra sạch.
- Để phun nước rửa lỗ khoan - hãy phun bằng vòi áp lực đến khi thấy nước ra sạch.
- Lưu ý! Lấy hết nước trên lỗ khoan và thổi bằng khí nén không dầu cho đến khi lỗ khoan hoàn toàn khô trước khi bơm vữa (không dùng cho lỗ khoan bằng búa trong ứng dụng dưới nước).

#### **▲ Bảo đảm rằng vữa được bơm vào lỗ khoan từ chỗ trong cùng mà không tạo ra các bọt khí.**

- Nếu cần thiết, sử dụng thiết bị phụ kiện để tiếp cận chỗ trong cùng của lỗ khoan.
- Đối với các ứng dụng trên cao, hãy sử dụng phụ kiện trên cao HIT-SZ và cần đặc biệt chú ý khi đưa vào thành phần định vị. Keo thừa có thể bị đẩy ra khỏi lỗ khoan. Phải đảm bảo không có mảng vữa rớt trên dụng cụ lắp đặt.
- Nén gấn vôi trộn mới vào gói đã mở trước đó, cần phải bỏ đi lớp trên cùng của gói.
- Gói mới phải dùng vôi trộn mới.

#### **▲ Không tuân theo các hướng dẫn lắp đặt này có thể dẫn đến việc không thể định vị các điểm!**

vi

ระบบพุกเคมีสำหรับติดยึดเหล็กเสนและสลักในคอนกรีต

▶ ก่อนใช้งานผลิตภัณฑ์นี้ โปรดปฏิบัติตามคำแนะนำการใช้งานและคำเตือนด้านความปลอดภัยตามที่กำหนดโดยกฎหมาย

## Hiki HIT-RE 100

มีส่วนประกอบของ: บิส [4-(2,3-อีพอกซีโพรพอกซี)ฟีนิล] โพรเพน (A); Formaldehyde, oligomeric reaction products with 1-chloro-2,3-epoxypropane and phenol (A); Trimethylolpropane triglycidylether (A); m-Xylylenediamine (B);



(A,B)



(A,B)



(A)



(A)



### อันตราย

- |      |                                                              |
|------|--------------------------------------------------------------|
| H314 | เป็นสาเหตุให้ผิวหนังไหม้อย่างสาหัสและทำอันตรายต่อดวงตา (A,B) |
| H317 | อาจเป็นสาเหตุให้ผิวหนังแสดงอาการแพ้ (A,B)                    |
| H341 | มีข้อสงสัยว่าอาจเกิดความผิดปกติต่อพันธุกรรม (A)              |
| H360 | อาจเกิดอันตรายต่อการเจริญพันธุ์หรือทารกในครรภ์ (A)           |
| H411 | มีพิษต่อสิ่งมีชีวิตในน้ำพร้อมผลกระทบระยะยาว (A,B)            |

P280 สวมถุงมือป้องกัน/เสื้อผ้าป้องกัน/ที่ป้องกันตา/ที่ป้องกันหน้า

P262 ห้ามให้เข้าตา สัมผัสผิวหนัง หรือเยื่อเมือก

P302+P352 ถ้าสัมผัสผิวหนัง ล้างเบา ๆ ด้วยสบู่และน้ำจำนวนมาก ๆ

P305+P351+P338 หากเข้าตา: ชะด้วยน้ำอย่างระมัดระวังเป็นเวลาหลายๆนาทีถอดคอนแทกซ์เลนส์ถ้ายังอยู่ที่เดิม และสะตอกที่จะทำก็ให้ชะล้างต่อไป

P333+P313 หากเกิดการระคายเคืองที่ผิวหนังหรือเป็นผื่นคัน: ให้ขอคำปรึกษา/ การรักษาพยาบาลจากแพทย์

P337+P313 หากการระคายเคืองที่ตายังไม่หาย: ให้ขอคำปรึกษา/ การรักษาพยาบาลจากแพทย์

### อุปกรณ์ป้องกันที่แนะนำให้ใช้:

การป้องกันตา: แวนตาที่ขอบปิดสนิท เช่น #02065449 แวนตานิรภัย PP EY-CA NCH แบบโปร่งใส และ #02065591 แวนครอบตา PP EY-HA R HC/AF แบบโปร่งใส;

การป้องกันมือ: EN 374 / EN 388; หลีกเลี่ยงการสัมผัสโดยตรงกับสารเคมี/ ผลิตภัณฑ์/ การผลิตโดยทำตามมาตรฐานของการองค์การ

ผู้ใช้ควรใช้วิจารณญาณในการเลือกใช้อุปกรณ์ป้องกันที่เหมาะสม

### การกำจัดทิ้ง

ตลอดผลิตภัณฑ์เหล่านี้ :

▶ หรือตามข้อกำหนดสำหรับรหัสของเสีย EAK 15 01 02 บรรจุกัมภ์พลาสติก

### ตลอดผลิตภัณฑ์ที่ยังไม่ได้อุ่นหรือใช้ไปบางส่วน :

▶ กำจัดทิ้งโดยใช้วิธีการสำหรับขยะพิเศษตามกฎหมายของบังคับของราชการ

- รหัสของเสีย EAK 20 01 27\* สี หมึก สารยึดติด และเรซินที่มีส่วนผสมของสารอันตราย

- รหัสหรือรหัสของเสีย EAK 08 04 09\* สารยึดติดและสารสำหรับซีลที่มีส่วนผสมของสารทำลายอินทรีย์หรือสารอันตรายอื่นๆ

ปริมาณ: 330 มล. / 11.1 ออนซ์ (ของเหลว)

500 มล. / 16.9 ออนซ์ (ของเหลว)

น้ำหนัก: 475 ก. / 16.7 ออนซ์

723 ก. / 25.5 ออนซ์

Hilti ไม่รับผิดชอบความเสียหายหรือการสูญเสียคุณสมบัติการใช้งานซึ่งเกิดจาก :

- การจัดเก็บและการขนส่งที่ไม่เป็นไปตามข้อกำหนด
- การไม่ปฏิบัติตามคำแนะนำการใช้งานและข้อมูลระยะเวลาการแข็งตัว รวมทั้งการใช้งานผิดวิธี
- การออกแบบจุดยึดสลักที่ไม่แข็งแรงเพียงพอ วัสดุที่ทำการติดตั้งมีความสามารถในการรับน้ำหนักไม่เพียงพอ
- สาเหตุอื่นๆ ซึ่ง Hilti ไม่สามารถคาดเดาได้ล่วงหน้าหรือ ไม่มีความเกี่ยวข้องกับ Hilti เช่น การใช้งานร่วมกับ ผลิตภัณฑ์อื่น ๆ

### ขอมูลผลิตภัณฑ์

- โปรดเก็บเอกสารคำแนะนำการใช้งานนี้ไว้คู่กับผลิตภัณฑ์เสมอ
- ถ้ามมีการส่งต่อผลิตภัณฑ์นี้ให้กับบุคคลอื่น ๆ จะต้องมอบเอกสารคำแนะนำการใช้งานนี้ให้แก่บุคคลดังกล่าวด้วย
- เอกสารข้อมูลความปลอดภัยเคมีภัณฑ์ (MSDS) : ศึกษาข้อมูลจากเอกสาร MSDS ก่อนการใช้งาน
- ตรวจสอบวันหมดอายุ : สังเกตวันหมดอายุที่พิมพ์อยู่บนหลอดพอยล์ที่บริเวณติดตั้งหัวผสม (เดือน/ปี) ห้ามใช้งานผลิตภัณฑ์หมดอายุแล้ว
- อุณหภูมิของหลอดพอยล์ในระหว่างการใช้งาน : +5 °C ถึง 40 °C / 41 °F ถึง 104 °F
- ข้อกำหนดในการขนส่งและจัดเก็บ : เก็บไว้ในที่แห้งและเย็น ไม่ถูกแสง และมีอุณหภูมิระหว่าง +5 °C ถึง 25 °C / 41 °F ถึง 77 °F
- สำหรับการใช้งานที่ไม่มีอธิบายไว้/ใช้คานอกของที่จะระบุในเอกสารนี้ กรุณาติดต่อขอรับขอมูลจาก Hilti
- หลังจากเปิดหลอดพอยล์แล้ว จะต้องใช้ผลิตภัณฑ์ใหม่ภายใน 4 สัปดาห์ ให้จัดเก็บผลิตภัณฑ์ตามข้อกำหนดที่แนะนำโดยไม่ตองถอดหัวผสมออกจากหลอดพอยล์ เมื่อนำผลิตภัณฑ์มาใช้งานอีกครั้ง ให้ติดตั้งหัวผสมใหม่และฉีดพุกเคมีส่วนแรกทิ้ง

### คำเตือน



- ▲ การใช้งานผิดวิธีอาจทำให้พุกเคมีกระเด็นออกมาได้ หากพุกเคมีสัมผัสโดยตรงอาจทำให้เกิดความเสียหายต่อดวงตาที่ไม่สามารถรักษาได้ !
  - สวมแว่นตานิรภัยที่มีการป้องกันแนบหนา ถุงมือ และชุดป้องกันทุกเครื่องของงานพุกเคมี !
  - ห้ามฉีดพุกเคมีหยั่งงูไม่ได้ติดตั้งหัวผสมอย่างถูกต้อง
  - ติดตั้งหัวผสมใหม่ก่อนที่จะฉีดพุกเคมีจากหลอดพอยล์ใหม่ (ขนาดติดตั้งพอดี)
  - ขอควรระวัง ! หวมน้ำหัวผสมออกในขณะที่ระบบของหลอดพอยล์ยังมีแรงดันอยู่ ให้กดปุ่มปลดของปืนฉีดเพื่อป้องกันไม่ให้พุกเคมีกระเด็น
  - เมื่อใช้ท่อต่อเพิ่มความยาว : การขับพุกเคมีออกในขั้นต้นจะดันเค้นเป็นการผ่านทางหัวผสมที่จัดเตรียมไว้ให้เท่านั้น (ไม่ใช่ผ่านที่ข้อต่อเพิ่มความยาว)
  - ใช้เฉพาะหัวผสมที่ใหม่พร้อมกับพุกเคมีเท่านั้น ห้ามดัดแปลงหัวผสมโดยเด็ดขาด
  - ห้ามใช้หลอดพอยล์ที่ชำรุด และ/หรือกระบอกครอบที่ชำรุดหรือไม่สะอาด
- ▲ จุดยึดอาจมีคุณสมบัติการรับน้ำหนักด้อยลงหรือไม่สามารถรับน้ำหนักได้ หากไม่ได้ทำความสะอาดอย่างเพียงพอจะจะต้องแห้ง ปราศจากเศษผง ฝุ่น น้ำ นู๊วแข็ง น้ำมัน จาระบี และสิ่งสกปรกอื่น ๆ ก่อนที่จะทำการฉีดพุกเคมี
  - Hilti คอกเจาะกลวง TE-CD, TE-YD ต้องใช้ร่วมกับเครื่องดูดฝุ่น Hilti ที่ได้รับการบำรุงรักษาอย่างถูกต้องพร้อมด้วยรูปแบบและความสามารถในการไหลเวียน (อัตราการไหลปริมาณ) ตามที่ระบุไว้ในตารางเสริม
  - สำหรับการเป่าลมไกลตัวในรูเจาะ ให้เป่าลมที่ปราศจากละอองน้ำมันและไขมันรูเจาะจนกระทั่งลมที่ออกมาจากรูเจาะไม่มีเศษฝุ่นเหลืออยู่
  - สำหรับการฉีดน้ำไล่เศษในรูเจาะ ให้ฉีดน้ำด้วยแรงดันปกติจากท่อจนกระทั่งน้ำที่ไหลย้อนออกจากรูเจาะไม่มีเศษฝุ่นเหลืออยู่
  - สำหรับการฉีดน้ำไล่เศษในรูเจาะ ให้ฉีดน้ำด้วยแรงดันปกติจากท่อจนกระทั่งน้ำที่ไหลย้อนออกจากรูเจาะไม่มีเศษฝุ่นเหลืออยู่
  - สำคัญ ! ให้อุ่นตัวทั้งหมดออกจากรูเจาะ และเป่าด้วยลมอัดที่ปราศจากไอน้ำมันจนกระทั่งรูเจาะแห้งสนิท ก่อนฉีดพุกเคมี (ไม่สามารถใช้ตัวกั้นที่เจาะด้วยสว่านกระแทกในการใช้งานได้น้ำ)
- ▲ ตรวจสอบให้แน่ใจว่าได้ฉีดพุกเคมีโดยเริ่มจากด้านในสุดของรูเจาะและไม่เกิดฟองอากาศ
  - ถ้าจำเป็น ให้ใช้อุปกรณ์เสริมรวมทั้งท่อเพิ่มความยาว เพื่อให้สามารถฉีดพุกเคมีได้ถึงด้านในสุดของรูเจาะ
  - สำหรับการทำงานเหนือศีรษะ ให้ใช้อุปกรณ์เสริมสำหรับการทำงานเหนือศีรษะ HIT-SZIP และใช้ความระมัดระวังขณะติดตั้งสลักกั้นท่ พุกเคมีบางส่วนอาจถูกดันออกจากรูเจาะได้ ห้ามใช้พุกเคมีหยุดใส่สลับกับติดตั้ง
  - ในกรณีที่ใช้หัวผสมใหม่กับหลอดพอยล์ที่เคยเปิดใช้มาก่อนแล้ว จะต้องฉีดพุกเคมีส่วนแรกทิ้ง
  - สำหรับหลอดพอยล์ใหม่ จะต้องใช้หัวผสมใหม่ทุกครั้ง
- ▲ การไม่ปฏิบัติตามคำแนะนำการติดตั้งข้างต้น อาจส่งผลให้จุดยึดมีคุณสมบัติการรับน้ำหนักด้อยลงหรือไม่สามารถรับน้ำหนักได้ !

th

<b>CE</b>
21
Hilti Corporation, LI-9494 Schaan Hilti Werke
2873-CPR-201-20
ETA-15/0882
Notified Body 2873
EAD 330499-00-0601
Injection system for use in concrete
<a href="http://www.hilti.group">www.hilti.group</a>

<b>CE</b>
21
Hilti Corporation, LI-9494 Schaan Hilti Werke
2873-CPR-201-21
ETA-15/0883
Notified Body 2873
EAD 330087-00-0601
Injection system for rebar connection
<a href="http://www.hilti.group">www.hilti.group</a>



\*Information sur le niveau d'émission de substances volatiles dans l'air intérieur, présentant un risque de toxicité par inhalation, sur une échelle de classe allant de A+ (très faibles émissions) à C (fortes émissions).



Certified to  
NSF/ANSI/CAN 61

## Made in Germany

Hilti = registered trademark of  
Hilti Corporation, Schaan, Liechtenstein  
[www.hilti.group](http://www.hilti.group)

© 2024 Right of technical changes reserved S.E. & O



2127554 V8-04.2024